

fisso sintetici

IT soluzioni convenienti in materiale plastico per il fissaggio di pannelli leggeri: per tutte le applicazioni dai coprivite ai distanziali, dal policarbonato al nylon, nascosti oppure visibili.



fisso kunststoff





DE günstige lösungen aus kunststoff zur befestigung leichter materialien: für alle anwendungen von der abdeckkappe bis zum distanzhalter, von polycarbonat bis nylon, verdeckt oder sichtbar.

fisso synthetics

EN good value fasteners in synthetics for light-weight material: for all applications from caps to spacers, from polycarbonate to nylon, visible or blind mounted.



							
micro plast	tube	klipser	fixxo	ghost	panel connector	x-man	pixfix
442	442	442	443	444	444	445	446

			
pixfix safe	con	digiplug	connector
447	448	449	449

micro plast

MADE IN EU design by KD

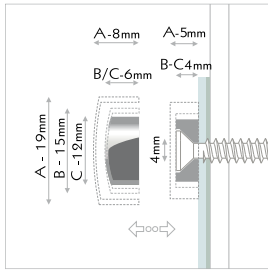

IT conveniente coprivite a pressione. montaggio diretta a parete. fissare il coprivite a pressione direttamente sull'anellino. fissaggio: sistema a vite a pressione, montaggio frontale, per luoghi poco accessibili. materiale: materiale plastico colorato.

DE preisgünstiges Klicksystem. direkte wandmontage, micro dekokappe einfach aufklicken. befestigung: frontales schraub-klicksystem. material: kunststoff farbig.

EN budget-priced fastener with click system. direct wallmounting, simply click the micro head on the fastener. mounting: frontal screw-clicksystem, material: coloured synthetics.

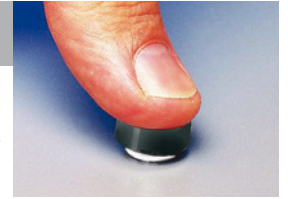

nero schwarz black		1box	pz/st/pc
FMISY1000SZ	Ø12mm, 80pcs		
FMISY1500SZ	Ø15mm, 80pcs		
bianco weiss white		1box	pz/st/pc
FMISY1000WE	Ø12mm, 80pcs		
FMISY1500WE	Ø15mm, 80pcs		

combinations



tube

MADE IN EU quality control by KD

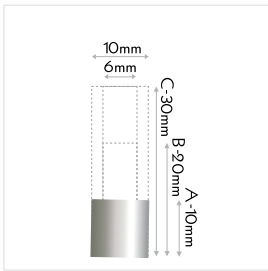

IT distanziale in acrilico. bussole per viti in acrilico di 2mm di spessore, convenienti e robuste. fissaggio: distanziale a bussola per tutti gli usi. materiale: acrilico trasparente.

DE abstandshülse, acryl. preisgünstige und robuste schraubenhülse in 2mm starkem acryl. universell verwendbar. material: transparentes acryl.

EN sleeve, acrylic. budget-priced and robust screw sleeve made of 2mm thick acrylic. mounting: screw sleeve, all-purpose. material: transparent acrylic.



combinations



trasparente transparent transparent		1box	pz/st/pc
FTU1010	10mm, 100pcs		
FTU1030*	30mm, 100pcs		

* fino ad esaurimento scorte | solange vorrat reicht | while stock last

klipser

MADE IN EU design by KD

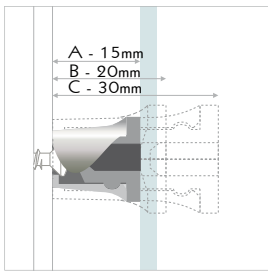

IT sistema di fissaggio a pressione, da incollare, invisibile, senza fori. fissare la bussola a parete, incollare la testina al pannello con biadesivo, silicone o colla, agganciare il pannello alla bussola. materiale: acrilico bianco/trasparente.

DE klebe-klicksystem, versteckt, ohne lochbohrung. hülse wandmontie-ren. material mit silikon, doppel- oder flüssigkleber direkt auf dem kopf befestigen. panel einklicken. material: acryl weiss/transparent.

EN glue-clicksystem, invisible, no holes. wallmount the spacer. fix the panel with adhesive tape, silicone or superglue directly to the head. click in the panel. material: acrylic, white/transparent.



trasparente transparent transparent		1box	pz/st/pc
FKL1515	15mm, Ø15mm, 100pcs		
FKL2020	20mm, Ø20mm, 50pcs		
FKL2030	30mm, Ø20mm, 50pcs		



fixxo

patented

MADE IN EU design by KD

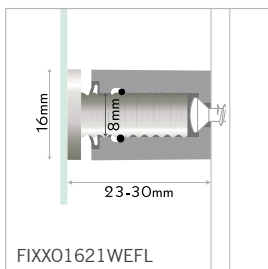
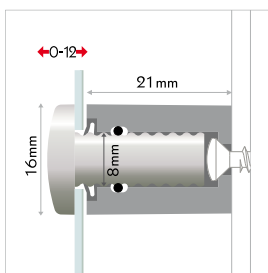

FIXXO1621WEFL

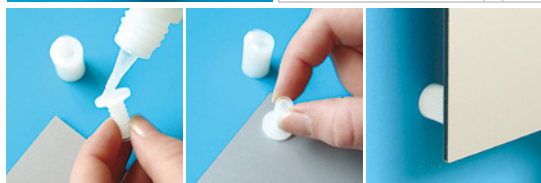

fixxo in colore bianco con la testa piatta (FIXXO1621WEFL) per montaggi invisibili di pannelli senza fori.

fixxo weiss mit flachkopf (FIXXO1621WEFL) für die unsichtbare montage ohne lochbohrung.

fixxo white with a flat head (FIXXO1621WEFL) for invisible mounting without holes.

combinations

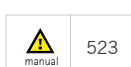
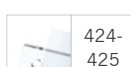
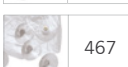
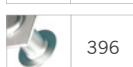

IT sistema variabile zigrinato. fissare il distanziale alla parete, posizionare il pannello, premere la testina nel foro e attraverso il pannello. le lamelle elastiche e sottili assicurano un fissaggio perfetto del pannello. la molletta laterale in acciaio blocca la testa del distanziale ed impedisce che la targa possa venir manomessa. fixxo in colore bianco è disponibile anche con la testa piatta (FIXXO1621WEFL) per montaggi invisibili di pannelli senza fori: incollare la testina direttamente al pannello con biadesivo, silicone o colla a due componenti. materiale: policarbonato o nylon cromato. distanza dalla parete: 21mm. spessore del pannello: fino a max 12mm.

DE variables raster-klemmsystem. abstandhalter wandmontieren, kopf durch das paneel schieben und im distanzer einrasten. elastische plättchen sorgen für satte auflage des paneels. manipulationsschutz durch seitlich einschiebbare edelstahlfeder. fixxo weiss erhältlich mit flachkopf (FIXXO1621WEFL) für die unsichtbare montage ohne lochbohrung: material mit doppel-, silikon- oder 2-komponenten-kleber direkt auf dem kopf befestigen. material: transparentes polycarbonat bzw. farbiges oder verchromtes nylon. wandabstand: 21mm. plattenstärke: bis max.12mm.

EN variable grid-clampsystem. wallmount the spacer, put the head through the panel and snap in the spacer. elastic small plates keep the panel solid seated. retractable stainless steel spring prevents from manipulation. fixxo white is available also with a flat head (FIXXO1621WEFL) for invisible mounting without holes: fix the panel with adhesive tape, silicone or superglue directly on the fixxo head. material: transparent polycarbonate resp. coloured or plated nylon. wall distance: 21mm. sign thickness: up to 12mm.

	nero satinato schwarz matt black matt	1 box	pz/st/pc
	FIXXO1621MSZ	40pcs	
	grigio satinato grau matt grey matt		
	FIXXO1621GR	40pcs	
	color vetro glasgrün glassgreen		
	FIXXO1621GG	40pcs	
	bianco weiss white		
	FIXXO1621WE	40pcs	
	FIXXO1621WEFL	40pcs	

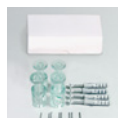



ghost patented

MADE IN EU design by KD

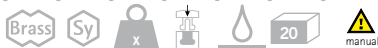
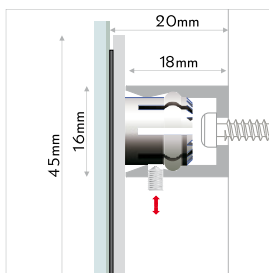

- ⚠** si prega di verificare se l'applicazione scelta è adatta per materiale e peso. quando si sceglie il montaggio con adesivi seguire le istruzioni del manuale rigorosamente.
- ⚠** unbedingt testen, ob sich ihre gewählte anwendung für material und gewicht eignet. v.a. wenn sie befestigung mit klebstoffen wählen, befolgen sie die bedienungsanleitung.
- ⚠** every application must be tested if suitable for material and weight, esp. when using adhesives follow manual instructions carefully.

IT il distanziale invisibile e semplice da montare. per tutti i casi in cui non siano graditi i distanziali visibili e quando si debba o si voglia rinunciare a forare la targa. posizionare sulla targa i distanziali in polycarbonato e fissarli nella parte posteriore; marcare sulla parete i punti da forare con i piccoli biadesivi e avvitare alla parete i distanziali in nichel; agganciare la targa al muro esercitando una lieve pressione. materiale: polycarbonato, ottone nichelato.

DE unsichtbare befestigung mit montagehilfe. immer wenn sichtbare halter unerwünscht sind und sie auf löcher verzichten müssen oder wollen. polycarbonathalter mit den randabstandsbugeln positionieren, auf der schildrückseite befestigen, bohrlöcher mit den doppelklebern an der wand ganz einfach markieren, wandhülsen andübeln und das schild einklicken. material: polycarbonat, messing vernickelt.

EN invisible fastener with fit-up aid. when you want to hide the fastener and you cannot or will not have holes in your sign. post the polycarbonate fastener using the removable leaves on your sign, fasten it with screws, glue, tape or silicone, mark the boreholes on the wall using the smart adhesive stickers, wallmount the spacers and click in the sign. material: polycarbonate, brass nickel-plated.

combinations

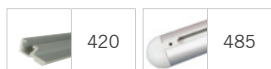

ghost | ghost | ghost

FG4618K

20pcs

1box

pz/st/pc

panel connector

MADE IN EU design by KD

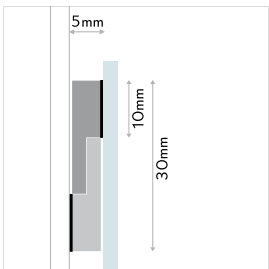
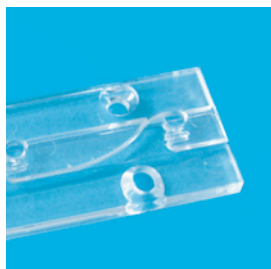

IT binario di fissaggio laterale da incollare, invisibile. montare una parte a parete, l'altra incollarla con biadesivo, silicone o colla sul pannello. fissaggio con viti anche possibile. i pannelli sono così facilmente intercambiabili. materiale: acrilico trasparente.

DE einerschub-schiene zum kleben, unsichtbar. ein teil wandmontieren, den anderen mit doppelkleber, silikon oder zwei-komponenten-kleber auf dem pannel befestigen. schrauben-montage auch möglich. pannel aufdrücken, fertig. jederzeit abnehmbar. material: kunststoff transparent.

EN slide-in rail, invisible. mount one part to the wall the other on the panel with double adhesive tape, silicone or superglue, fixing with screws also possible. press on the panel, ready. panels can be taken off anytime. material: transparent synthetics.



trasparente | transparent | transparent

FPC20100

20pcs

1box

pz/st/pc

x-man

MADE IN EU design by KD

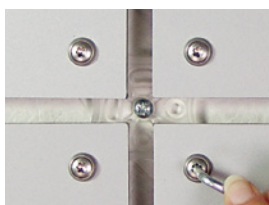
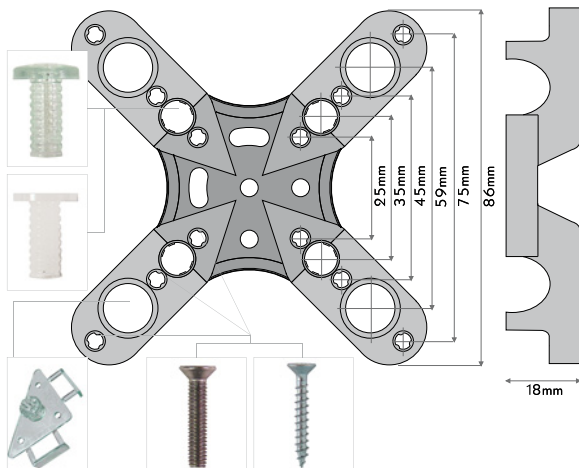

fissaggio di pannelli con viti.
panelbefestigung mit schrauben.
panel mounting with screws.

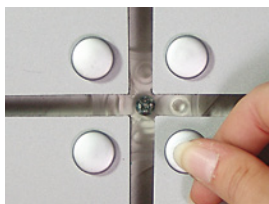

fissaggio di pannelli con il distanziale zigrinato fixxo.
panelbefestigung mit fixxo klücksystem.
panel mounting with fixxo click-in.

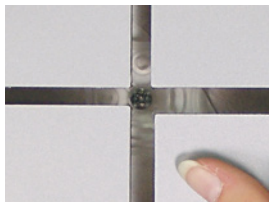

fissaggio invisibile di pannelli con ghost oppure con fixxo (FIXXK16WEFL).
unsichtbare panelbefestigung mit ghost oder fixxo (FIXXK16WEFL).
invisible panel mounting with ghost or fixxo (FIXXK16WEFL).

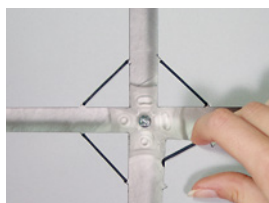

fissaggio dei pannelli con anellini di silicone.
panelbefestigung mit silikon-ringen.
panel mounting with silicone oring.

IT x-man: un talento nascosto. per il fissaggio di rivestimenti, pannelli, sistemi di informazione e molto di più. il fissaggio può essere visibile o invisibile, con viti, viti truciolori o con colla, fisso o rimovibile. ideale per luoghi di ingresso con molti pannelli o per pareti mobili. x-man può essere montato centralmente o su un angolo. a seconda delle esigenze x-man può essere usato in combinazione con i nostri distanziali e accessori. fissaggio: attacco a parete per viti, colla o a pressione. materiale: acrilico trasparente. nota bene: si prega di verificare se l'applicazione scelta è adatta per materiale e peso.

DE x-man: das multitalent im hintergrund. für die befestigung von verkleidungen, paneelen, informationssystemen und vielem mehr. befestigung sichtbar oder unsichtbar, mit schraube, holzschraube oder kleber, zum abnehmen oder fix montiert. ideal für eingangsbereiche mit vielen schildern oder für mobile wände. x-man kann zentriert oder auf eck montiert werden. kombinieren sie x-man je nach bedarf mit unseren abstandhaltern und montagehilfen. befestigung: wandhalterung zum schrauben, kleben oder klicken. material: kunststoff, transparent. wichtiger hinweis: bitte testen sie die gewählte anwendung vorab auf eignung für material und gewicht.

EN x-man: allrounder in the background. for mounting of panelings, panels, information systems and much more. fastening is visible or invisible, with screw, woodscrew or glue, removable or fix. perfect for lobbies with a lot of signs or for mobile walls. you can mount x-man centered or on the corner. combine x-man according to your needs with our spacers and fit-up aids. mounting: wall holder for screwing, gluing or clicking. material: transparent synthetic. important note: please test in advance the choosen application if suitable for material and weight.

combinations

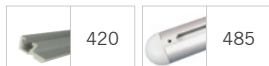

chiaro | klar | clear
FXMAN1885 2pcs 1box pz/st/pc



col. vetro | glasgrün | glassgreen
FIXXK16GG 40pcs



bianco | weiss | white
FIXXK16WEFL 40pcs



chiaro | klar | clear
FGK4618K 20pcs

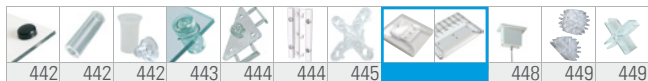

pixfix 100x100

MADE IN EU design by KD

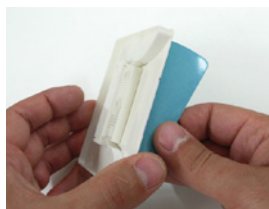
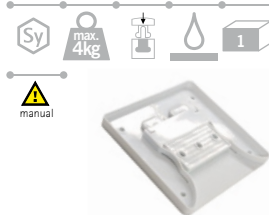
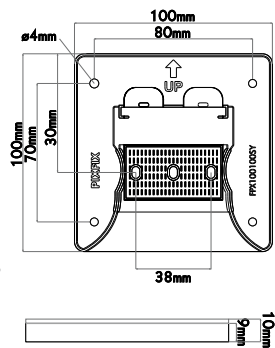
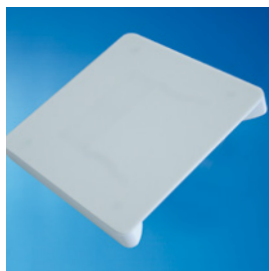

rimuovere il foglio di protezione del biadesivo
doppelkleberfolie abziehen
remove adhesive tape foil



incollare pixfix al pannello
pixfix am panel aufkleben
mount pixfix to the panel

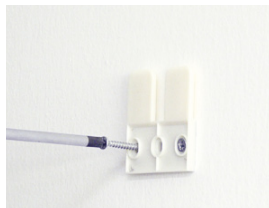

rimuovere la parte di pixfix che va a parete e montarla
wandhalter abnehmen und wandmontieren
mount the wall support to the wall

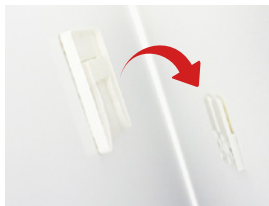

inserire il pannello sul supporto a parete montato in precedenza
paneel einfach auf wandhalter einklicksen
simply click in your panel



IT pixfix vi entusiasmerà: il vostro pannello può essere fissato a parete in modo completamente invisibile e senza essere forato. grazie all'intelligente sistema di inserimento, i pannelli possono inoltre venir cambiati in qualsiasi momento. pixfix può essere fissato alla targa da esporre già direttamente in officina, così da risparmiare tempo sul luogo del montaggio. le dime per il montaggio sono davvero pratiche: si segnano così sul muro i punti dove effettuare i fori con il trapano, senza bisogno di prendere altre misure a vuoto. pixfix si adatta a tutti i materiali perchè può anche essere fissato ai pannelli con delle viti. distanza dal muro: 10mm.

DE pixfix wird sie begeistern: ganz ohne lochbohrung und unsichtbar wird ihr paneel befestigt. dank des cleveren einschubsystems können sie die paneele auch jederzeit ganz einfach austauschen. die befestigung von pixfix am paneel kann bereits in der werkstatt erfolgen, so sparen sie zeit bei der montage. praktisch die montageschablone: bohrlöcher werden einfach durch andrücken markiert, ohne umständliches ausmessen. pixfix ist geeinet für alle materialien und lässt sich auch mit schrauben am paneel befestigen. wandabstand: 10mm

EN pixfix will inspire you: without the need for holes in your panel and it secures it invisibly. thanks to the clever insert system you can simply exchange the panels at anytime. you can mount pixfix to your panels already in the work shop, saving time on-site later. the label positioning is convenient: press on the pixfix and drill holes which are simply marked on the wall. pixfix is suitable for all materials and can be also mounted with screws to the panel. distance from wall: 10mm



⚠ si prega di verificare se l'applicazione scelta è adatta per materiale e peso. quando si sceglie il montaggio con adesivi seguire le istruzioni del manuale rigorosamente.

⚠ unbedingt testen, ob sich ihre gewählte anwendung für material und gewicht eignet. v.a. wenn sie befestigung mit klebstoffen wählen, befolgen sie die bedienungsanleitung.

⚠ every application must be tested if suitable for material and weight, esp. when using adhesives follow manual instructions carefully.



pixfix
FPX100100SY

pz/st/pc

1pc

pixfix safe 150x200

MADE IN EU design by KD

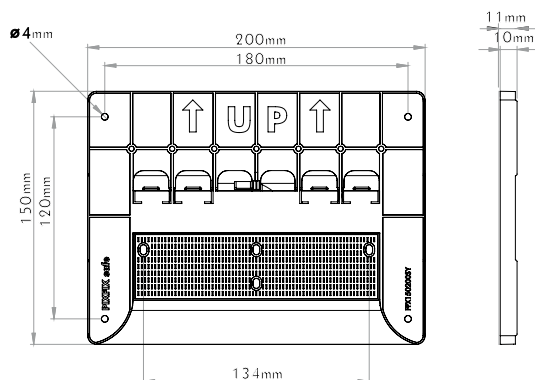
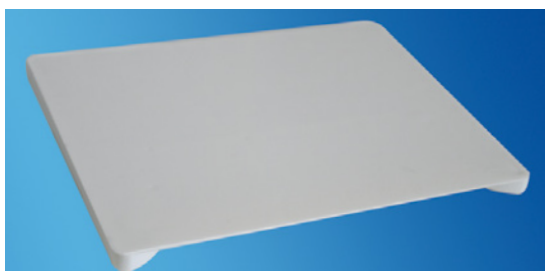

intelligente sistema a prova di furto
clevere diebstahlsicherung
thief-proof design



IT con il grande pixfix safe facciamo un grosso salto in avanti: adesso potrete fissare a parete senza doverle forare e con un sistema invisibile anche targhe e pannelli di grandi dimensioni. I pannelli possono essere incollati o avvitati al sistema di fissaggio. il clou: un sistema integrato di chiusura, di sicurezza, può essere attivato, a scelta, dopo il montaggio. in questo modo la vostra targa è a prova di furto. la calamita per tale uso è da ordinare separatamente.

DE mit dem grossen pixfix safe gehen wir einen schritt weiter: grosse platten befestigen sie damit unsichtbar und ohne lochbohrung. paneele können aufgeklebt oder aufgeschraubt werden. der clou: eine eingebaute sperre kann nach montage optional aktiviert werden. ihr panel ist damit manipulationsgeschützt und diebstahlsicher montiert. bestellen sie hierzu extra den passenden magneten.

EN with the bigger pixfix safe we go one step further: big panels can be mounted invisibly and without any holes. panels can be fixed with adhesive tape, glue or screws. the chief attraction: an integrated lock can be optionally activated after mounting easily. thus your panel is tamper- and thief-proof mounted. order the matching magnet extra.

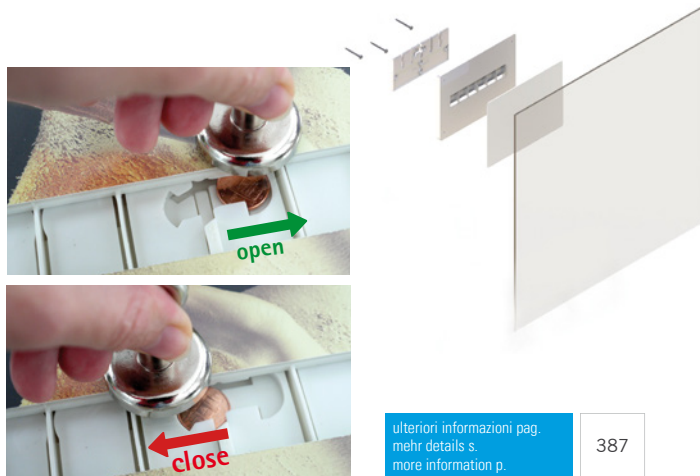

ulteriori informazioni pag.
mehr details s.
more information p.

387

⚠ si prega di verificare se l'applicazione scelta è adatta per materiale e peso. quando si sceglie il montaggio con adesivi seguire le istruzioni del manuale rigorosamente.

⚠ unbedingt testen, ob sich ihre gewählte anwendung für material und gewicht eignet. v.a. wenn sie befestigung mit klebstoffen wählen, befolgen sie die bedienungsanleitung.

⚠ every application must be tested if suitable for material and weight, esp. when using adhesives follow manual instructions carefully.



pixfix safe

FPX150200SY

1pc

pz/st/pc

magnet

ACALPF

magnet, 1pc

pz/st/pc



con

MADE IN EU design by KD

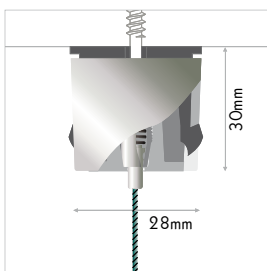

fissare il tirante a soffitto
halter deckenmontieren
mount the support to the ceiling

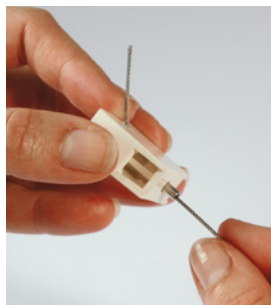

inserire il cavo nel sistema matic
seil duch den matic-verschluss
einziehen
insert the cable through the self-lock
system



agganciare il fermacavo
seilhalter aufklipsen
clip on the cable support



il fermacavo può essere rimosso in
qualsiasi momento
seilhalter kann einfach jederzeit
wieder entfernt werden
cable support can be removed easily
anytime



IT fermacavo per montaggi a soffitto con sistema matic di chiusura in materiale plastico. fissare il tirante a soffitto, inserire il cavo, agganciare ed il gioco è fatto. Fissaggio: fermacavo con sistema matic; distanza dal soffitto: 28mm, spessore del cavo: max. ø1,2mm

DE seilhalter für deckenmontage mit matic schnellverschluss aus kunststoff. halter deckenmontieren, seil montieren, aufklipsen, fertig. befestigung: seilhalter maticsystem, abstand: 28mm, seilstärke max. ø1,2mm

EN synthetic cable support for ceiling with matic locksystem. mount the support to the ceiling, fix the cable, clip on the cable support. mounting: cable support, self-closing, wall distance: 28mm, cable thickness: max. ø1,2mm.

combinations

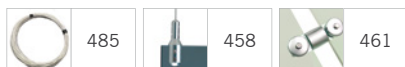

con
FCN2928

20pcs

1box

pz/st/pc

digiplug

MADE IN CHINA quality control by KD

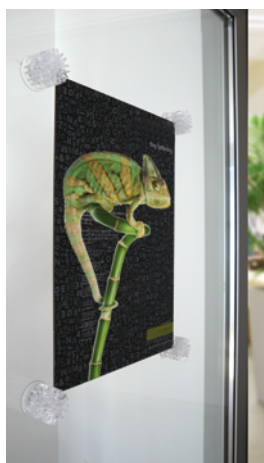

ulteriori informazioni pag.
mehr details s.
more information p.

192

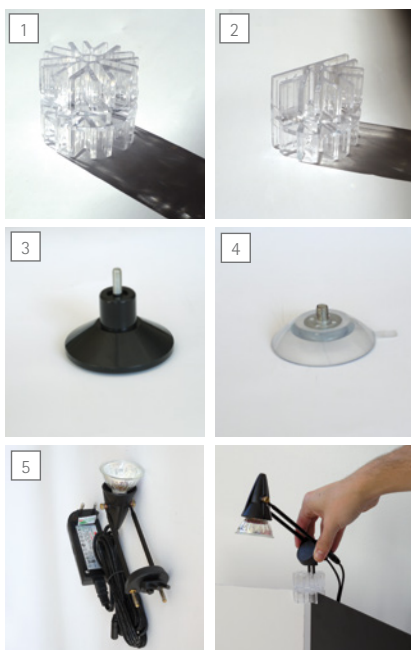

IT leggero, facile da usare, veloce da installare: ecco digiplug, il connettore ad 8 vie per pannelli con spessore di 4 mm. digiplug è particolarmente consigliato con pannelli leggeri, di piccole dimensioni e quadrati, perchè il connettore si monta sugli angoli, non in mezzo. digiplug da un lato è filettato, per consentirne l'utilizzo con tutta una serie di accessori. Vi offriamo digiplug come set completo fornito in un a pratica valigetta per il trasporto o a singoli componenti.

DE schnell leicht und einfach: das ist digiplug 8-wege verbinder für 4mm starke paneele. besonders empfiehlt sich digiplug mit kleinformatigen, quadratischen leichtstoffplatten, da digiplug an den ecken, nicht mittig, eingesetzt wird. jeder digiplug hat an einer seite ein gewinde für die befestigung von zubehör. wir bieten ihnen digiplug als kompletset im praktischen transportkoffer oder als einzelkomponente an.

EN quick, light and easy: this is digiplug, the 8-way connector for 4mm panels. especially recommended is digiplug with small sized, squared lightweight panels as the connector is used at the corners, not in the middle. every digiplug comes with a thread on one side for mounting the accessories. we offer digiplug as a complete set with handy transport case or as single components.

			pz/st/pc
1	DPLU8TR	digiplug full, transparent, 1pc	
2	DPLU5TR	digiplug half, transparent, 1pc	
3	DPLUREG	digiplug regulator, 1pc	
4	DPLUAVEN	digiplug suction cup, 1pc	
5	DPLULMP	digiplug lamp, 1pc	

connector

MADE IN TAIWAN quality control by KD



IT sistema modulare per vetrine ad incastro. realizzate la vostra personalissima vetrina con pannelli da 5mm ed i fissaggi angolari connector in policarbonato color vetro. a seconda della forma e delle dimensioni della vostra applicazione, ordinate i singoli pezzi che vi servono. gli esempi qui riproposti vi aiutano nella scelta del fissaggio giusto.

DE schlagfeste eckverbinder aus glasgrünem polycarbonat für cuben nach dem baukasten-system. gestalten sie ihre persönliche vetrine mit connector eckhaltern und 5mm-paneeelen. die beispilskizzen helfen Ihnen bei der richtigen auswahl der entsprechenden eckverbinder.

EN shock-resistant panel-connector made of glassgreen polycarbonate for modular cube systems. create your personal vetrine with 5mm-panels and connectors. the drawings with examples help you choosing the right parts.

ulteriori informazioni pag.
mehr details s.
more information p.

194

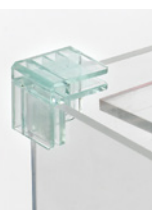
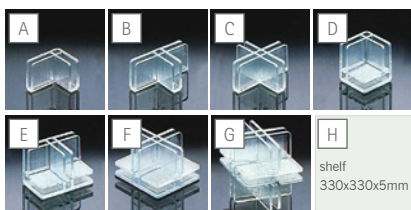

			pz/st/pc
A	FCONA		1pc
B	FCONB		1pc
C	FCONC		1pc
D	FCOND		1pc
E	FCONE		1pc
F	FCONF		1pc
G	FCONG		1pc
H	FCON330PL	shelf, transparent acrylic, 330x330x5mm	