

ghost 386	pixfix 100x100 387	pixfix safe 150x200 388	backframe 390	ring kombo 392	ring steel ring 392	nano 393	micro plast micro steel 393	micro 394	mini 394	midi 395	budget 396
corner border 403	safe fast 404	rapid 406	three four six 407	cubix 408	mix alu 410	mix 412	steel 13-50 414	clamper 416	unico 418	clip rail x-man 420-422	wall-style 423







ring steel 432	nano 432	micro steel 432	steel safe 433	fixxo bond fixxo steel 433	steel 13-50 434-435	fisso shot 436	steel plus 436	steel univers 437	steel ceiling-matic 437	steel pinch 437	steel union 438

micro plast 442	tube 442	klipser 442	fixxo 443	ghost 444	panel connector 444	x-man 445	pixfix 446	pixfix safe 447	con 448	digiplug 449	connector 449

ceiling style 452	plus 454	plusmatic 454	con 455	fix 456	plusmini 456	plusdesign 456	loop 457	steel plus 457	steel univers 457	steel ceiling-matic 458	steel pinch 458

hook 460	univers mini 460	univers matic 460	union design 461	steel union 461	steel unite 461	uniplus 462	uniplus style 462	steel uniplus 462	steel wall pinch 463	punto 463	button 463

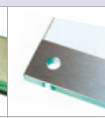
desk 466	table 466	punto 467	aven 467	croco cube 468	set antenna/ arco 468	antenna components 469	digiplug 470	connector 471	ix bond 472	artrail 473



			
rosett zoom 396-397	fixxo bond fixxo shot 397-398	fixxo 400	peso maxi 401-402
			
infoglass 424	infoplate glassgreen square 424/5	infoquick infoplate round 426	maxipack 427-429

FISSO WALL

distanziali a parete
wandmontiert
on the wall

386-429



	
steel unite 438	steel uniplus 439

FISSO STEEL

acciaio
stahl
steel

432-439

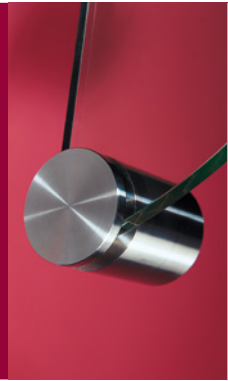

FISSO SYNTHETICS

sintetici
kunststoff
synthetics

442-449



			
univers 458	universdesign 459	perla 459	lasso 459

FISSO CEILING

soffitto e bandiera
decke und fahne
ceiling and flagsigns

452-463

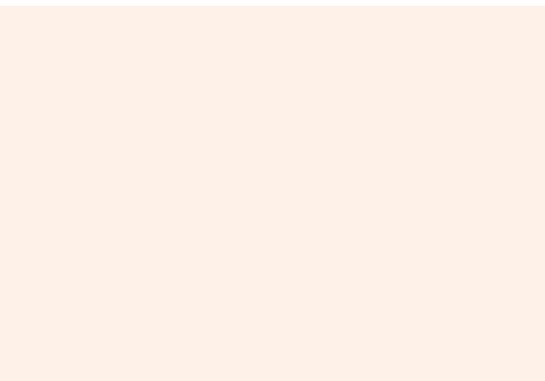

FISSO SPECIAL

speciali
spezial
special

466-473



FISSO WALL

distanziali a parete

IT tutte le forme e le dimensioni dei distanziali a parete: nascosti oppure visibili, in ottone con cromatura di qualità, in acciaio inox oppure in materiale plastico. ideale per interni ed esterni, a prova di manomissioni ma anche facili e veloci da cambiare.





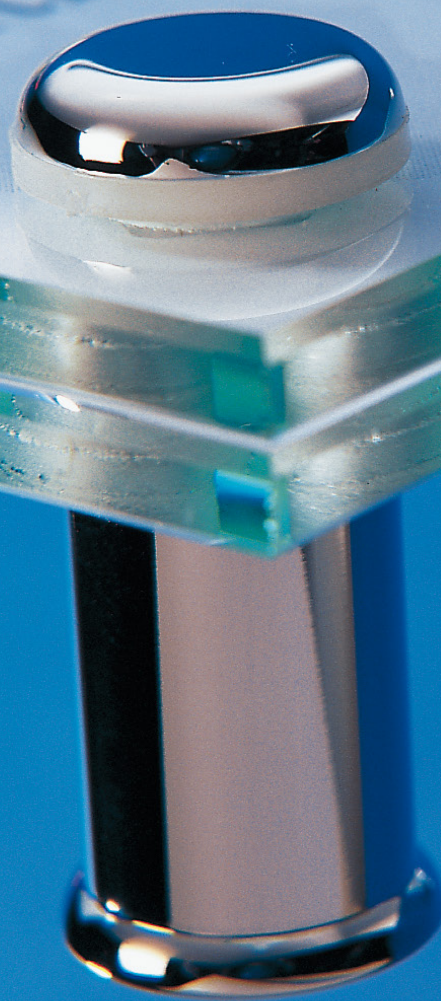

wandmontiert

DE alle möglichkeiten und grössen der wandmontierten befestigung: verdeckt oder sichtbar, aus messing veredelt, rostfreiem stahl oder kunststoff, für den innen- oder aussenbereich, manipulationsgeschützt oder für den schnellen wechsel.

on the wall

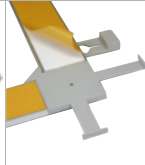
EN all the variety and sizes of wallmounted fasteners: visible or blind, made of plated brass, stainless steel or synthetic material, for inside or outside use, with protection against manipulation or for fast replacement.

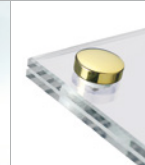

							
ghost	pixfix 100x100	pixfix safe 150x200	backframe	ring kombo	ring steel ring	nano	micro plast
386	387	388	390	392	392	393	393

							
micro steel	micro	mini	midi	budget	rosett	zoom fixxo bond	fisso shot
393	394	394	395	396	396	397	398

							
fixxo	peso	maxi	corner border	safe	fast	rapid	three four six
400	401	402	403	404	405	406	407

							
cubix	mix alu	mix	steel 13-50	clamper	unico	clip rail x-man	wall-style
408	410	412	414	416	418	420-422	423

				
infoglass	infoplate glassgreen square	infoquick	infoplate round	maxipack
424	424/5	426	426	427

ghost patented

MADE IN EU design by KD

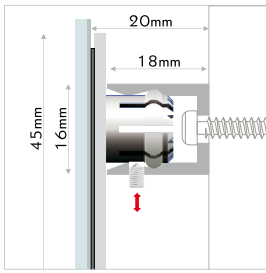
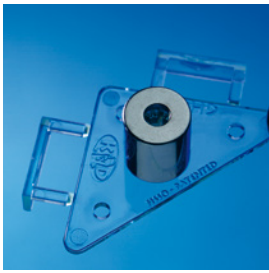

i distanziali in policarbonato possono venir fissati al pannello con della colla, silicone o biadesivo. su materiali adatti, con un certo spessore, è possibile fissare i distanziali con delle viti

abstandhalter können mit geeignetem flüssigkleber, silikon oder doppelkleber befestigt werden. bei entsprechendem material schrauben sie die abstandhalter an

spacers can be mounted to the sign with appropriate glue, silicone or double faced adhesive tape. with adequate material mounting with screws is possible



⚠️ si prega di verificare se l'applicazione scelta è adatta per materiale e peso. quando si sceglie il montaggio con adesivi seguire le istruzioni del manuale rigorosamente.

⚠️ unbedingt testen, ob sich ihre gewählte anwendung für material und gewicht eignet. v.a. wenn sie befestigung mit klebstoffen wählen, befolgen sie die bedienungsanleitung.

⚠️ every application must be tested if suitable for material and weight, esp. when using adhesives follow manual instructions carefully.

combinations

	420		485
--	-----	--	-----



IT il distanziale invisibile e semplice da montare. per tutti i casi in cui non siano graditi i distanziali visibili e quando si debba o si voglia rinunciare a forare la targa. posizionare sulla targa i distanziali in policarbonato (dotati di alette laterali staccabili per prendere la distanza dal bordo del pannello) e fissarli nella parte posteriore; marcare sulla parete i punti da forare grazie ai piccoli biadesivi e avvitare alla parete i distanziali in nichel; in seguito basterà agganciare la targa al muro esercitando una lieve pressione. fissaggio: a pressione, invisibile, per targhe e pannelli senza fori, veloce da cambiare, semplice da montare. materiale: policarbonato, ottone nichelato.

DE unsichtbare befestigung mit montagehilfe. immer wenn sichtbare halter unerwünscht sind und sie auf löcher verzichten müssen oder wollen. polycarbonathalter mit den randabstands-bügeln positionieren, auf der schilderrückseite befestigen, bohrlöcher mit den doppelklebern an der wand ganz einfach markieren, wandhülsen andübeln und das schild einklicken. befestigung: klicksystem, unsichtbar, für schilder ohne lochbohrung, schnell gewechselt, einfache montage. material: polycarbonat, messing vernickelt.

EN invisible fastener with fit-up aid. when you want to hide the fastener and you cannot or will not have holes in your sign. post the polycarbonate fastener using the removable leaves on your sign, fasten it with screws, glue, tape or silicone, mark the boreholes on the wall using the smart adhesive stickers, wallmount the spacers and click in the sign. mounting: click system, invisible, for signs without holes, quick to change, easy to mount. material: polycarbonate, brass nickel-plated.



ghost | ghost | ghost
FG4618K 20pcs 1box pz/st/pc

pixfix 100x100

MADE IN EU design by KD

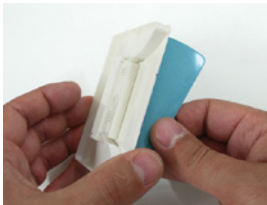
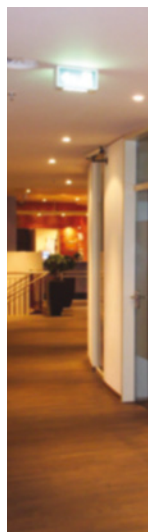
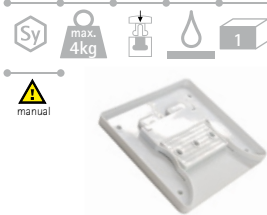
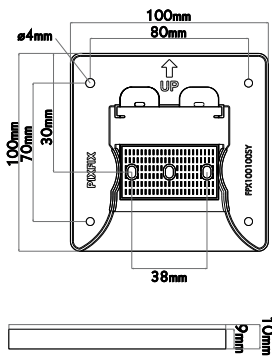
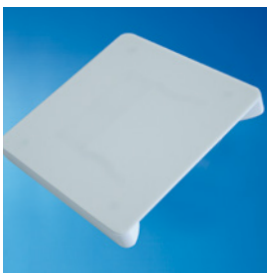

rimuovere il foglio di protezione del biadesivo
doppelkleberfolie abziehen
remove adhesive tape foil



incollare pixfix al pannello
pixfix am paneel aufkleben
mount pixfix to the panel

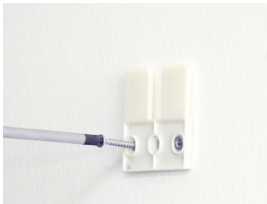

rimuovere la parte di pixfix che va a parete e montarla
wandhalter abnehmen und wandmontieren
mount the wall support to the wall

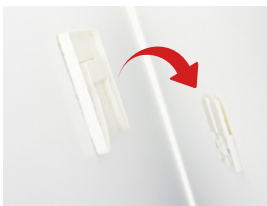

inserire il pannello sul supporto a parete montato in precedenza
paneel einfach auf wandhalter einklicken
simply click in your panel

IT pixfix vi entusiasmerà: il vostro pannello può essere fissato a parete in modo completamente invisibile e senza essere forato. grazie all'intelligente sistema di inserimento, i pannelli possono inoltre venir cambiati in qualsiasi momento. pixfix può essere fissato alla targa da esporre già direttamente in officina, così da risparmiare tempo sul luogo del montaggio. le dime per il montaggio sono davvero pratiche: si segnano così sul muro i punti dove effettuare i fori con il trapano, senza bisogno di prendere altre misure a vuoto. pixfix si adatta a tutti i materiali perchè può anche essere fissato ai pannelli con delle viti. distanza dal muro: 10mm.

DE pixfix wird sie begeistern: ganz ohne lochbohrung und unsichtbar wird ihr paneel befestigt. dank des cleveren einschubsystems können sie die paneele auch jederzeit ganz einfach austauschen. die befestigung von pixfix am paneel kann bereits in der werkstatt erfolgen, so sparen sie zeit bei der montage. praktisch die montageschablone: bohrlöcher werden einfach durch andrücken markiert, ohne umständliches ausmessen. pixfix ist geeignet für alle materialien und lässt sich auch mit schrauben am paneel befestigen. wandabstand: 10mm

EN pixfix will inspire you: without the need for holes in your panel and it secures it invisibly. thanks to the clever insert system you can simply exchange the panels at anytime. you can mount pixfix to your panels already in the work shop, saving time on-site later. the label positioning is convenient: press on the pixfix and drill holes which are simply marked on the wall. pixfix is suitable for all materials and can be also mounted with screws to the panel. distance from wall: 10mm



⚠ si prega di verificare se l'applicazione scelta è adatta per materiale e peso. quando si sceglie il montaggio con adesivi seguire le istruzioni del manuale rigorosamente.

⚠ unbedingt testen, ob sich ihre gewählte anwendung für material und gewicht eignet. v.a. wenn sie befestigung mit klebstoffen wählen, befolgen sie die bedienungsanleitung.

⚠ every application must be tested if suitable for material and weight, esp. when using adhesives follow manual instructions carefully.



pixfix
FPX100100SY

1pc

pz/st/pc



pixfix safe 150x200

MADE IN EU design by KD



IT con il grande pixfix safe facciamo un grosso salto in avanti: adesso potrete fissare a parete senza doverle forare e con un sistema invisibile anche targhe e pannelli di grandi dimensioni. I pannelli possono essere incollati o avvitati al sistema di fissaggio. il clou: un sistema integrato di chiusura, di sicurezza, può essere attivato, a scelta, dopo il montaggio. in questo modo la vostra targa è a prova di furto. la calamita per tale uso è da ordinare separatamente.

DE mit dem großen pixfix safe gehen wir einen schritt weiter: große platten befestigen sie damit unsichtbar und ohne lochbohrung. paneele können aufgeklebt oder aufgeschraubt werden. der clou: eine eingebaute sperre kann nach montage optional aktiviert werden. ihr panel ist damit manipulationsgeschützt und diebstahlsicher montiert. bestellen sie hierzu extra den passenden magneten.

EN with the bigger pixfix safe we go one step further: big panels can be mounted invisibly and without any holes. panels can be fixed with adhesive tape, glue or screws. the chief attraction: an integrated lock can be optionally activated after mounting easily. thus your panel is tamper- and thief-proof mounted. order the matching magnet extra.

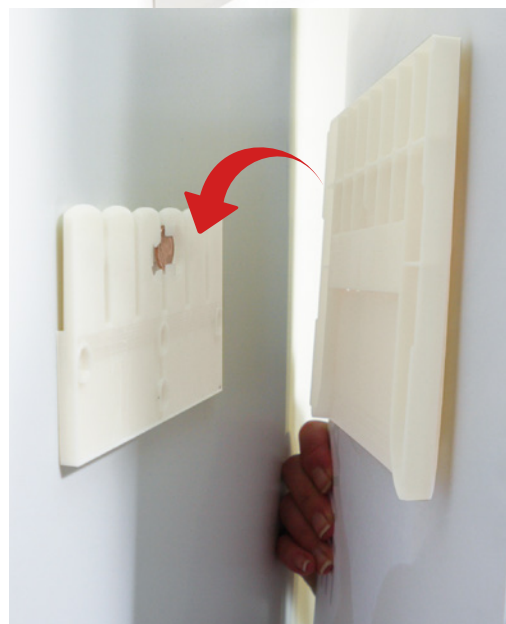
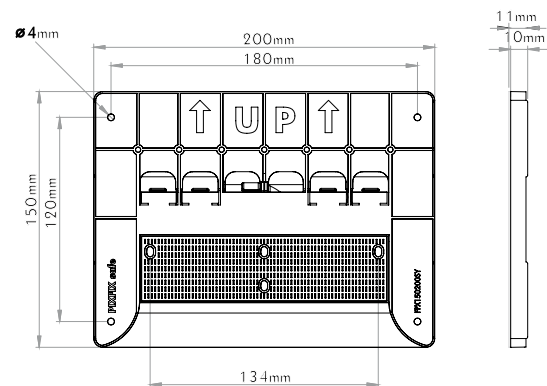
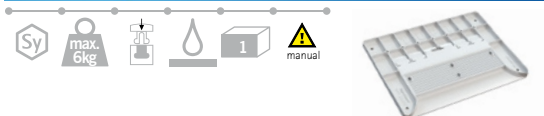

pixfix safe
FPX150200SY 1pc pz/st/pc

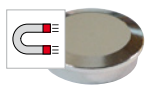

pixfix
ACALPF magnet, 1pc pz/st/pc

⚠ si prega di verificare se l'applicazione scelta è adatta per materiale e peso. quando si sceglie il montaggio con adesivi seguire le istruzioni del manuale rigorosamente.

⚠ unbedingt testen, ob sich ihre gewählte anwendung für material und gewicht eignet. v.a. wenn sie befestigung mit klebstoffen wählen, befolgen sie die bedienungsanleitung.

⚠ every application must be tested if suitable for material and weight, esp. when using adhesives follow manual instructions carefully.



sistema brevettato a prova di furto: per fissare il pannello alla parete sarà sufficiente spostare la moneta al suo interno con un magnete, in questo modo il pixfix safe non potrà più essere rimosso. Per sbloccarlo sarà sufficiente avvicinare il magnete al pannello spostando la moneta e facendola tornare nella posizione iniziale, a questo punto sarà possibile rimuovere il pannello.

patente diebstahlsicherung: durch verschieben der innenliegenden münze mit magnet wird das wandmontierte panel abgeschlossen, der pixfix kann nicht mehr nach oben gezogen werden. zum öffnen einfach mit dem magnet über das panel fahren, die münze bewegt sich in die ausgangsposition und schon lässt sich das panel wieder abnehmen.

tamperproof design: by moving the coin inside with magnet the wall mounted panel is locked, the pixfix cannot be moved upwards when locked. for opening simply move the magnet over the panel and the coin turns back into the initial position and the panel can be simply removed.

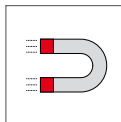



backframe

MADE IN EU design by KD

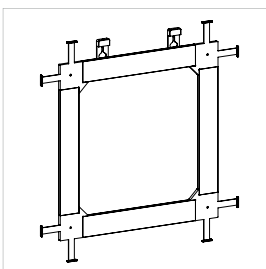
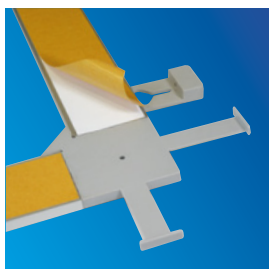

IT backframe provvede egregiamente al fissaggio, tra gli altri, di pannelli flessibili e sottili, come per esempio i semi espansi, il forex o l'alluminio, perchè assicura una tenuta perfetta, semplice ed estremamente sicura. particolarmente pratico è il sistema di livellatura che backframe offre e che può essere regolato fino a 10 mm, in modo che il vostro pannello sia sempre appeso diritto in modo perfetto, senza dover riforare il muro per riattaccarlo. offriamo backframe come set completo nei formati più comuni; in caso di richiesta sono disponibili altre lunghezze per formati su misure.

DE backframe sorgt als ein befestigung v.a. für flexible, dünne paneele z.b. aus hartschaum, forex oder aluminium für die nötige versteifung. zugleich befestigt der backframe ihr pannel sicher und einfach. besonders praktisch dabei die nivellierung fürs aufgehängte pannel, die vertikal bis zu 10mm unterschied reguliert, so dass ihr pannel immer gerade hängt ohne dass neu gebohrt werden muss. wir bieten ihnen backframe als komplettes set für gängige formate an. ausserdem erhalten sie auch alle seitenlängen extra für weitere formate.

EN backframe is a mounting system especially for thin and flexible panels made of hard-foam, forex or aluminium. it helps to stiffen the panel, while mounting is easy and safe. the leveling system is particularly convenient for the mounted panel, that can even be up to 10mm, so that your panel will always be straight without drilling new holes. we provide you with complete sets for common formats. also available are all lengths extra to create new sizes.



included



4 profili in alluminio anodizzato color argento, 4 angolari in materiale plastico, quantità necessaria per livellatura a parete, cacciavite

4 silber eloxierte aluminiumprofile, 4 kunststoff eckverbinder, entsprechende nivellierungswandhaken, inbus-schlüssel



4 silver anodized aluminium profiles, 4 plastic edge connectors, needed quantity of leveling wall hooks, allen key

backframe complete set

			pz/st/pc
1	FBAFA3	complete set for A3, 1pc	
2	FBAF700500	complete set for 700x500mm, 1pc	
3	FBAFA1	complete set for A1, 1pc	
4	FBAF1000700	complete set for 1000x700mm, 1pc	
5	FBAF14001000	complete set for 1400x1000mm, 1pc	

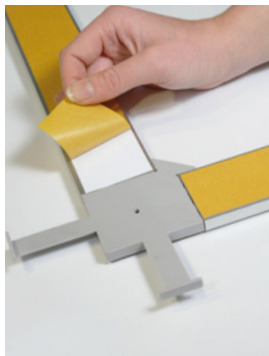
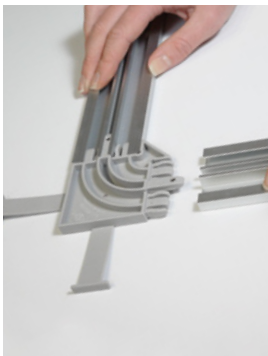

costruire la cornice, applicare il biadesivo, posizionare la cornice sul muro grazie al sistema di alette laterali per il montaggio, staccare tali alette e attaccare il pannello alla parete.

rahmen zusammenbauen, doppelklebeband aufbringen, rahmen mittels montagehilfen positionieren, montagehilfen abreißen, paneel aufhängen.

assemble the frame, put on the double sided adhesive tape, position the frame with the positioning straps, tear away straps, wall mount the panel



optional

l'angolo della struttura può anche essere avvitato al pannello.

optional kann der eckverbinder auch direkt mit paneel verschraubt werden

you have the option of also screw the edge connector directly to the panel

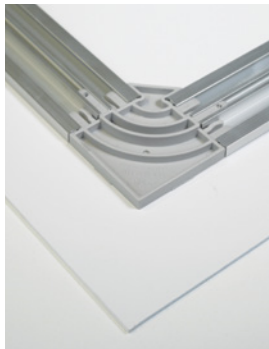
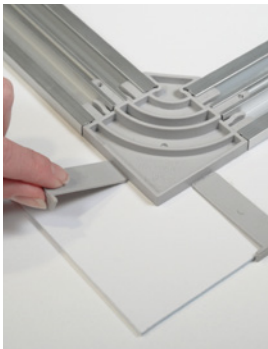

fissaggio a parete con livellatura: corregge dislivelli fino a 10mm dopo il montaggio.

wandbefestigung mit nivellierung: gleicht bis zu 10mm nach montage aus.

wall hook with levelling: evens up to 10mm after wall mount.

ulteriori informazioni pag. mehr details s. more information p.

150

backframe wall lock

MADE IN EU design by KD

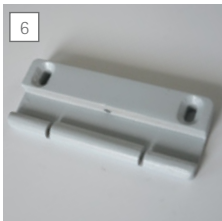

6

agganci a parete a prova di furto non livellabili in altezza, materiale plastico

wandhaken mit diebstahlsicherung, nicht höhen-nivellierbar, kunststoff

wall hook with theft protection, without leveling, synthetic



intelligente sistema a prova di furto: montate il wall lock a parete, sia nella parte superiore che in quella inferiore, agganciate il backframe e fissate il grano di sicurezza

clevere diebstahlsicherung: wall lock für oben und unten wandmontieren, backframe einhängen und die obere madenschraube festziehen

intelligent anti-theft system: mount the wall lock for upper and lower side, attach the backframe and close the upper grub screw

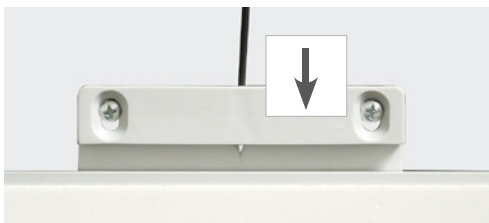

a prova di manomissione: con il grano fissato il backframe non potrà essere rimosso

keine chance für langfinger: mit angezogener schraube kann der backframe nicht mehr abgenommen werden

no chance for thieves. with the grub screw tightened the backframe cannot be removed

wall hook

6 FBAFSH

wall lock, 2pcs

ring kombo

MADE IN EU design by KD

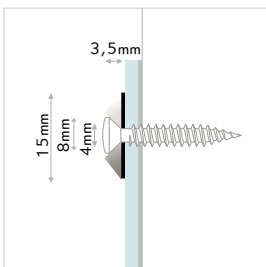

IT graziosa vite torx in inox, dotata di anellino in acciaio e gommino di protezione per non graffiare il materiale; pieno appoggio anti-scivolo. fissaggio: sistema a vite, montaggio frontale, uso universale. materiale: anellino e vite torx in acciaio inox, gommino di protezione.

DE ästhetische edelstahlschraube komplett mit edelstahl-ring und einlage. kein verkratzen des materials, rutschfeste, satte auflage. befestigung: schraubensystem, frontale montage. material: ring, torxschraube edelstahl, schutzeinlage gummi.

EN appealing stainless steel torx screw complete with stainless steel jacket and inlay. no scratching, non-slip solid seating. mounting: screw system, all-purpose. material: stainless steel ring with rubber, torx screw stainless steel.



Steel Sy 10kg 80 4

combinations

	442		424-425
--	-----	--	---------

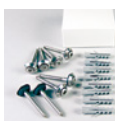

acciaio | stahl | steel

FRING15KB

Ø15mm, 80pcs

1box

pz/st/pc

ring steel

MADE IN EU design by KD

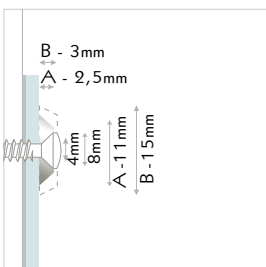

IT rosetta in acciaio massiccio. montaggio diretto a parete, per ogni tipo di materiale di qualsiasi spessore; fissaggio: sistema a vite, montaggio frontale, uso universale. materiale: acciaio inox AISI304, vite torx in acciaio inox.

DE rosette aus massivem edelstahl. direkte wandmontage, für alle materialien jeder stärke. befestigung: schraubensystem, frontale montage, universell verwendbar. material: edelstahl AISI304, torxschraube edelstahl.

EN rosette in solid stainless steel. mounting directly to the wall, for all materials, unlimited thickness. mounting: screw system, frontal mounting, all-purpose. material: stainless steel AISI304, torxscrew stainless steel.



Sy 15kg 40 4

combinations

	442		424-425
--	-----	--	---------



acciaio | stahl | steel

FRG11IX

Ø11mm, 40pcs

1box

pz/st/pc

FRG15IX

Ø15mm, 40pcs

ring

MADE IN EU design by KD

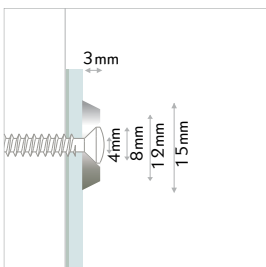

IT anellino in ottone pregiato. montaggio diretto a parete, per ogni tipo di materiale, con cromatura di qualità sulla superficie. fissaggio: sistema a vite, montaggio frontale, uso universale. materiale: anellino in ottone cromato, vite torx in acciaio inox.

DE veredelter messingring. direkte wandmontage, für alle materialien, mit hochwertiger oberflächenveredelung. befestigung: schraubensystem, frontale montage. material: torxschraube edelstahl.

EN plated brass ring, for all materials, stainless steel torx screw, high-quality plated brass ring. mounting: screw system, frontal mounting, all-purpose. material: solid plated brass ring, torx screw stainless steel.



Brass Sy 10kg 40 4

combinations

	442		424-425
--	-----	--	---------



argento | silber | silver

FRG15AR *

Ø15mm, 40pcs

1box

pz/st/pc

* fino ad esaurimento scorte | solange vorrat reicht | while stock last

nano

MADE IN EU design by KD

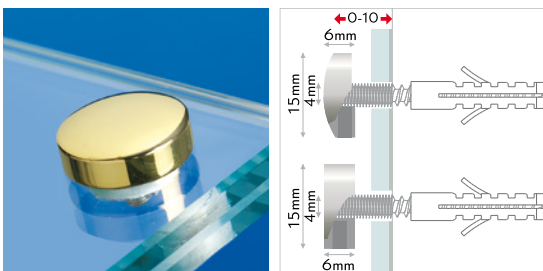

combinations

	442		424-425
--	-----	--	---------

IT coprivate decorativo avvitabile. per il fissaggio a parete tramite vite di congiunzione. fissaggio: montaggio frontale, per luoghi poco accessibili. materiale: ottone cromato o acciaio inox AISI304, rondella in nylon, vite di congiunzione.

DE stockschraube mit dekokappe. direkte wandmontage, befestigung: front-schraubsystem, für unzugängliche orte, material: messing veredelt bzw. edelstahl AISI 304, nylon-beilagscheibe, stockschraube.

EN hanger screw with decor head. mounting directly to the wall, for hard accessible places. mounting: frontal screw system, material: plated brass or stainless steel AISI 304, nylon washer, hanger screw.

		1 box	pz/st/pc
	cromo chrom chrome		
	FNANO15CM	40pcs	
	argento silber silver		
	FNANO15AR	40pcs	
	oro gold gold		
	FNANO15GD	40pcs	
	acciaio stahl steel		
	FNANO15IX	40pcs	

micro plast

MADE IN EU design by KD

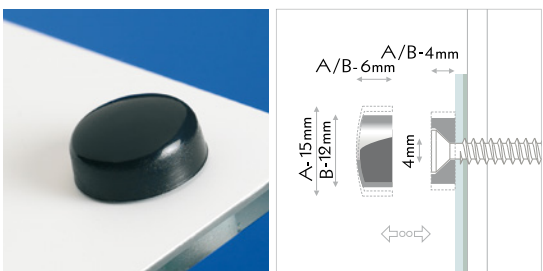

combinations

	442		424-425
--	-----	--	---------

IT conveniente coprivate a pressione. montaggio diretta a parete. fissare il coprivate a pressione direttamente sull'anellino. fissaggio: sistema a vite a pressione, montaggio frontale, per luoghi poco accessibili. materiale: materiale plastico colorato.

DE preisgünstiges klicksystem. direkte wandmontage, micro dekokappe einfach aufklicken. befestigung: frontales schraub-klicksystem. material: kunststoff farbig.

EN budget-priced fastener with click system. direct wallmounting, simply click the micro head on the fastener. mounting: frontal screw-klicksystem, material: coloured synthetics.

			1 box	pz/st/pc
	nero schwarz black			
	FMISY1000SZ	Ø12mm, 80pcs		
	FMISY1500SZ	Ø15mm, 80pcs		
	bianco weiss white			
	FMISY1000WE	Ø12mm, 80pcs		
	FMISY1500WE	Ø15mm, 80pcs		

micro steel

MADE IN EU design by KD

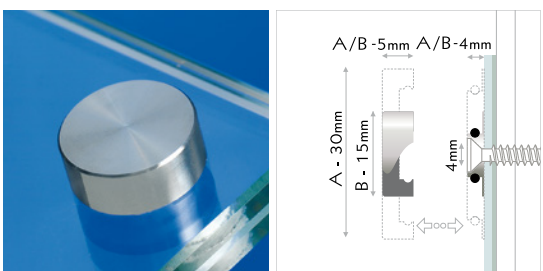

combinations

	420		485		442		424-425
--	-----	--	-----	--	-----	--	---------

IT coprivate decorativo in acciaio di qualità. il pannello si attacca a parete direttamente con il fissaggio micro. fissare il coprivate a pressione. fissaggio: sistema a vite a pressione, montaggio frontale, per luoghi poco accessibili. materiale: anellino in ottone, coprivate in inox AISI304.

DE hochwertige edelstahl dekokappe. paneel mit micro-halter direkt wandmontieren. micro dekokappe aufklicken. befestigung: schraub-klicksystem, frontmontage, für unzugängliche orte. material: halter messing, kappe AISI304 edelstahl.

EN high grade stainless steel deco head. mount the material with micro fastener directly on the wall. simply click the deco head on the fastener. mounting: frontal screw-klicksystem, for hard accessible places. material: fastener brass, head AISI304 steel.

			1 box	pz/st/pc
	acciaio stahl steel			
	FMI1500IX	Ø15mm, 40pcs		
	FMI3000IX*	Ø30mm, 40pcs		

* fino ad esaurimento scorte | solange vorrat reicht | while stock lasts

micro

MADE IN EU design by KD

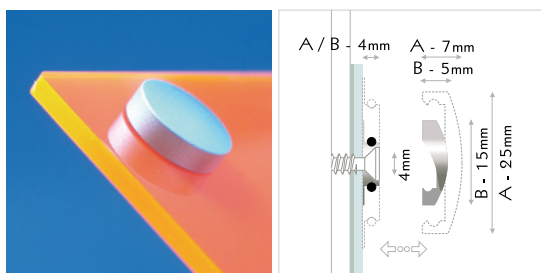

Brass, 15kg, 40, Ø15mm, 4

IT elegante coprivite a pressione. per il montaggio veloce e diretto a parete. fissaggio: sistema a vite a pressione, montaggio frontale, per luoghi poco accessibili. materiale: ottone, coprivite con cromatura.

DE edle dekokappe zum aufklicken. für schnelle und direkte wandmontage. befestigung: frontales schraub-klicksystem, für unzugängliche orte. material: messing, kappe veredelt.

EN noble deco head to click on. for quick and direct wall mounting. mounting: frontal screw-clicksystem, for hard accessible places, material: brass, head plated.

combinations

420 485 442 424-425

	chromo chrom chrome	1box	pz/st/pc
	FMI1500CM	Ø15mm, 40pcs	
	FMI2500CM	Ø25mm, 40pcs	
	argento silber silver		
	FMI1500AR	Ø15mm, 40pcs	
	FMI2500AR	Ø25mm, 40pcs	
	oro gold gold		
	FMI1500GD	Ø15mm, 40pcs	
	FMI2500GD	Ø25mm, 40pcs	

mini

patented

MADE IN EU design by KD

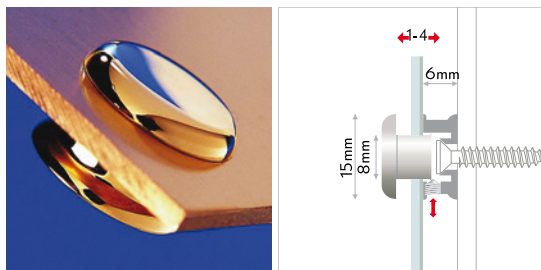

Brass, 15kg, 40, 9

IT sistema a brugola con chiusura laterale di sicurezza per piccoli formati. fissaggio: sistema a brugola con chiusura laterale di sicurezza, a prova di manomissione. materiale: ottone con cromatura.

DE stecksystem mit arretierung für kleine formate. befestigung: stecksystem mit arretierung, manipulationssicher. material: veredeltes messing.

EN plug-interlocksystem for small sizes. mounting: plug-interlocksystem, tamper-proof. material: plated brass.

combinations

420 485 396 467 424-425

	nero schwarz black	1box	pz/st/pc
	FN1506SZ*	40pcs	
	chromo chrom chrome		
	FN1506CM	40pcs	
	argento silber silver		
	FN1506AR	40pcs	
	oro gold gold		
	FN1506GD	40pcs	

* fino ad esaurimento scorte | solange vorrat reicht | while stock last

midi patented  MADE IN EU design by KD

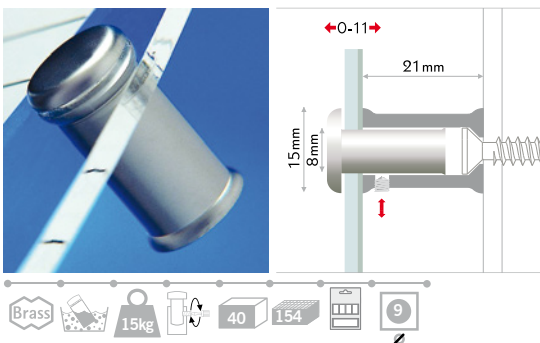





IT il classico sistema a brugola con chiusura laterale di sicurezza. fissare il distanziale alla parete, posizionare il pannello, inserire la testina nel foro e attraverso il pannello e completare il fissaggio tramite la brugola laterale di sicurezza, che impedisce che la targa possa venir manomessa o smontata. per lastre, targhe e pannelli di spessore medio. fissaggio: sistema a brugola con chiusura laterale di sicurezza, a prova di manomissione. materiale: ottone con cromatura color oro lucido, cromo lucido o argento satinato.

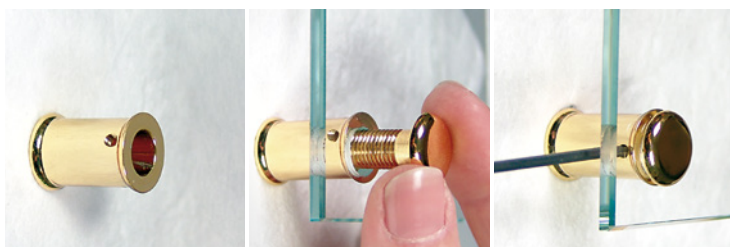

DE stecksystem mit arretierung für mittlere formate. halter an der wand befestigen, paneel auflegen, kopf durch das paneel in den halter stecken und mit seitlicher madenschraube im halter gegen manipulation sichern. für schilder, platten, paneele und borde mittlerer stärke. befestigung: stecksystem mit arretierung, manipulationsicher. material: messing oberflächenveredelt in gold, silber und chrom.

EN plug-interlocksystem for medium sizes. mount the fastener to the wall, put on the panel and plug the head through the panel into the fastener. fix the head in the fastener with the allen screw. for signs, panels and boards with medium size. mounting: plug-interlocksystem, tamper-proof. material: brass, gold-, silver- or chrome-plated. wall.



combinations

	420		485
	396		467
	424-425		

	cromo chrom chrome	F1521CM	40pcs
	argento silber silver	F1521AR	40pcs
	oro gold gold	F1521GD	40pcs

budget

MADE IN EU design by KD

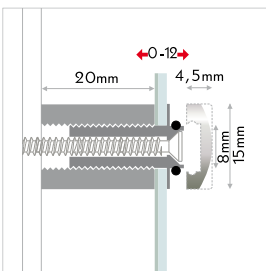
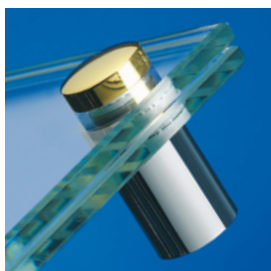

Brass 15kg 40 9

IT economico: premontare il pannello tra il distanziale e la parte centrale. avvitare la targa sul posto e posizionare la testina decorativa. fissaggio: sistema a vite, premontaggio. materiale: ottone, bussola nichelata, testina decorativa color oro, cromo o argento satinato.

DE ökonomisch: paneel zwischen hülse und wandhalter vormontieren. schild vor ort anschrauben, dekokappe aufdrücken. befestigung: schraubensystem für vormontage. material: messing, hülse vernickelt, dekokappe veredelt in gold, silber und chrom.

EN economical: pre-assemble panels between wall spacer and centerpiece. on site mount the sign to the wall, press on the deco-head. mounting: screwsystem for pre-assembly. material: brass, spacer nickel, deco head gold-, silver- or chrome-plated.

combinations

424-
425

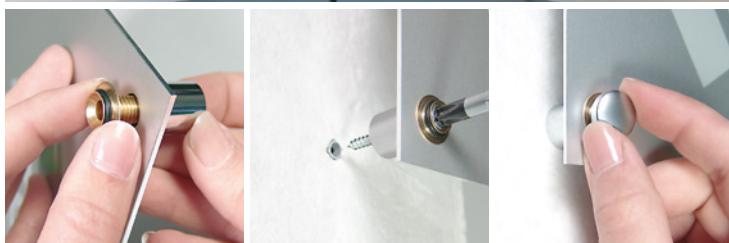

	cromo chrom chrome	1box	pz/st/pc
	FBUD1520CM	40pcs	
	argento silber silver		
	FBUD1520AR	40pcs	
	oro gold gold		
	FBUD1520GD	40pcs	

rosett

MADE IN EU design by KD

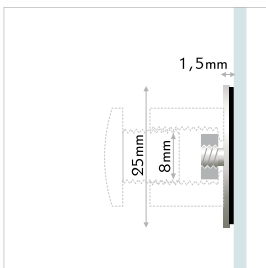

Brass manual 523 40



IT sistema di montaggio su vetro o superfici lisce con colla per distanziali. per distanziali fino a Ø25mm. fissaggio: sistema di montaggio su vetro. materiale: ottone cromato.

DE befestigungshilfe mit klebstoff auf glas und glatten oberflächen für distanzer. für distanzer bis Ø25mm. material: messing verchromt.

EN spacer mounting aid for glass and smooth surfaces with glue. for spacers with up to Ø25mm. material: chrome-plated brass.

combinations

	394		412
--	-----	--	-----



	cromato verchromt chrome-plated	1box	pz/st/pc
	FROS25CM	40pcs	

ZOOM

MADE IN EU design by KD

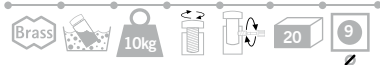
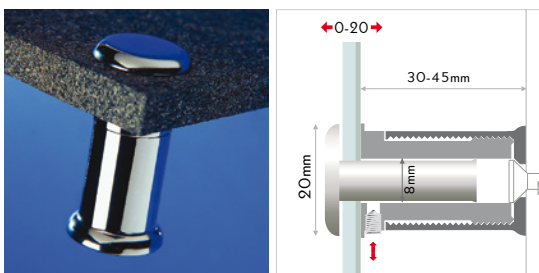

IT sistema di fissaggio con chiusura laterale di sicurezza, a distanza variabile dalla parete. fissare il distanziale alla parete, regolare la distanza dalla parete a piacere, svitando la parte centrale. ideale per il montaggio su pareti irregolari o inclinate. materiale: ottone con cromatura della superficie.

DE stecksystem mit arretierung, stufenlos variabler wandabstand, manipulationsgeschützt. halter an der wand befestigen, wandabstand durch aufschrauben der mittelhülse wie gewünscht einstellen. vor allem zum ausgleich bei unebenen oder schrägen wänden empfohlen. material: messing oberflächenveredelt

EN plug-interlocksystem infinitely variable wall distance, tamper-proof. mount the fastener to the wall, adjust the distance from wall by screwing the middle nut. especially recommended for the levelling of uneven or sloped walls. material: brass, plated.

combinations

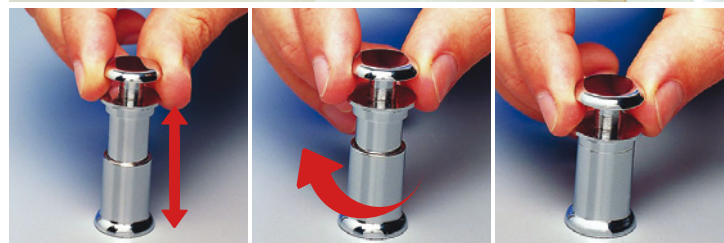
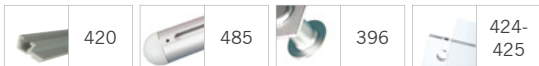

	cromo chrom chrome		1 box	pz/st/pc
	FZ2027CM	20pcs		
	argento silber silver			
	FZ2027AR	20pcs		

fixxo bond

patented MADE IN EU design by KD

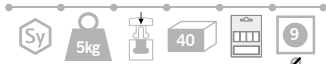
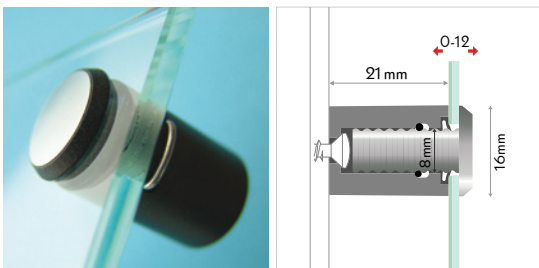

IT sistema variabile zigrinato con l'effetto inox, idoneo per l'esterno. l'insero in acciaio inox spazzolato fa un effetto speciale e puo essere personalizzato con stampa o adesivo. materiale: nylon color nero satinato, acciaio inox spazzolato.

DE variables raster-klemmsystem mit stahl-effekt, wetterfest. das gebürstete edelstahl-inlay im kopf verleiht effektvolle optik u. kann mit druck oder aufkleber personalisiert werden. befestigung: raster-klemmsystem, für unterschiedliche stärken. material: mattschwarzes nylon, gebürsteter edelstahl.

EN variable grid-clampsystem with steel-look, weather-proof. the brushed stainless steel inlay of the head gives a special steel look and can be customized with print or label. mounting: grid-clampsystem, for different thickness. material: black matt nylon, brushed stainless steel.

combinations

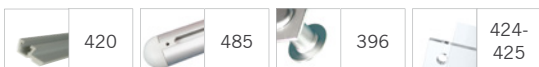

	cromo chrom chrome		1 box	pz/st/pc
	FB01621SZ	40pcs		



fisso shot

patented

MADE IN EU design by KD

NEW
PRODUCT

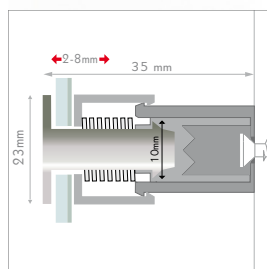

IT montaggio più veloce della luce! l'elegante distanziatore in acciaio inossidabile a pressione è adatto ad un fissaggio estremamente rapido del pannello. far passare la testa del distanziatore attraverso il foro del pannello e premere fino a che non si sente il click. fisso shot è l'ideale per l'applicazione di pannelli lisci. il sistema innovativo garantisce una sostituzione immediata del pannello, senza l'utilizzo di strumenti: il distanziatore si apre facilmente, sempre con una leggera pressione. fisso shot è ideale per utilizzare pannelli di grandi o piccole dimensioni che necessitano di essere cambiati spesso.

DE montage schnell wie ein schuss! eleganter distanzhalter mit pushsystem für extrem schnelles einspannen von paneelen. distanzhalter aus edelstahl wandmontieren, kopfstück durch das paneel schieben und per knopfdruck einklicken. mit fisso shot spannen sie stufenlos platten verschiedener stärken ein. das innovative system ermöglicht paneelaustausch ohne werkzeug: der clevere distanzhalter öffnet sich einfach wieder per knopfdruck. fisso shot ist ideal für anwendungen mit häufigem wechsel kleiner wie großer paneele.

EN mount it quick as a shot! elegant spacer with push system for extremely quick fixing of panels. wall mount the stainless steel spacer, put the head through the panel and click in place by simply pushing the head. with fisso shot you can stagelessly fix panels with different thicknesses. the innovative systems allows the exchange of panels without any tools: the clever spacers simply opens by pushing the head. fisso shot is perfect for applications that need to exchange panels of small and bigger sizes frequently.

information

- acciaio inossidabile con rivestimento in materiale sintetico di colore bianco
material: edelstahl mit weißer kunststoffhülse
material: stainless steel with white jacket in synthetics
- diametro testa del distanziale 23mm, distanza pannello dalla parete 32mm
durchmesser kopf 23mm, wandabstand paneel 32mm
diameter head 23mm, wall distance panel 32mm
- per pannelli di spessore compreso tra 2-8mm
für paneelstärken von 2-8mm
for panels with thickness 2-8mm
- peso supportato: 5kg
traglast: 5kg
max. load: 5kg

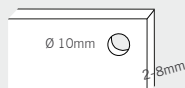

fisso shot

acciaio | stahl | steel
FST2332IX

20pcs

1box

pz/st/pc



fissare a parete i distanziali
distanzhalter wandmontieren
wall mount the spacer



appoggiare il pannello
paneel auflegen
put on the panel

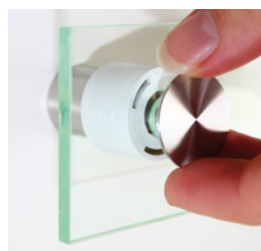

inserire la testa del distanziale
nel foro del pannello
kopf durch das paneel in den
distanzhalter stecken

put the head through the panel
into the spacer







premere semplicemente la testa
del distanziale per fissarlo così
a parete

einfach auf den kopf drücken und
in der wandhülse fixieren
simply push the head to fix it in the
wall spacer



advantages

-  fissaggio di pannelli con spessore da 1 a 8mm
platten von 1 bis 8mm stärke
clamp panels with 1 up to 8mm
-  sistema innovativo: il cambio del pannello non richiede l'uso di utensili, si chiude semplicemente a pressione
innovatives system: paneeltausch ohne werkzeug, einfach auf knopfdruck
innovative system: panel exchange without tools, just by pushing the head
-  cambio del pannello estremamente rapido
extrem schneller paneelaustausch
extremely quick panel exchange
-  testa del distanziale piatta e sfaccettata in acciaio inox di alta qualità
flacher kopf aus hochwertigem edelstahl mit facettenschliff
flat head made of high-grade stainless steel with faceted surface



fixxo patented  MADE IN EU design by KD

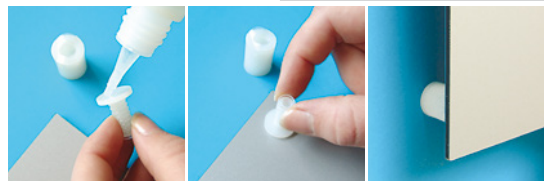
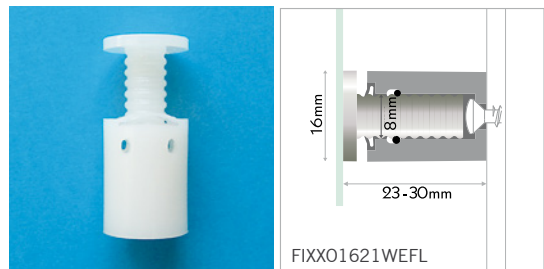
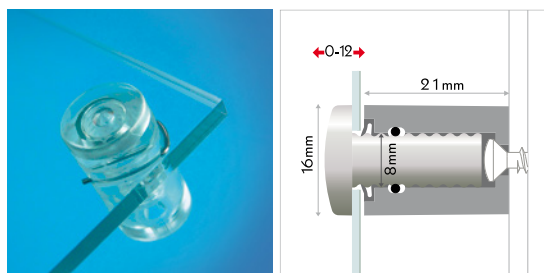







fixxo in colore bianco con la testa piatta (FIXXO1621WEFL) per montaggi invisibili di pannelli senza fori.

fixxo weiss mit flachkopf (FIXXO1621WEFL) für die unsichtbare montage ohne lochbohrung.

fixxo white with a flat head (FIXXO1621WEFL) for invisible mounting without holes.





combinations

	420		485
	396		467
	424-425		523

IT sistema variabile zigrinato. fissare il distanziale alla parete, posizionare il pannello, premere la testina nel foro e attraverso il pannello. le lamelle elastiche e sottili assicurano un fissaggio perfetto del pannello. la molletta laterale in acciaio blocca la testa del distanziale ed impedisce che la targa possa venir manomessa. fixxo in colore bianco è disponibile anche con la testa piatta (FIXXO1621WEFL) per montaggi invisibili di pannelli senza fori: incollare la testina direttamente al pannello con biadesivo, silicone o colla a due componenti. materiale: policarbonato o nylon cromato. distanza dalla parete: 21mm. spessore del pannello: fino a max 12mm.

DE variables raster-klemmsystem. abstandhalter wandmontieren, kopf durch das panel schieben und im distanzer einrasten. elastische plättchen sorgen für satte auflage des paneels. manipulationsschutz durch seitlich einschiebbare edelstahlfeder. fixxo weiss erhältlich mit flachkopf (FIXXO1621WEFL) für die unsichtbare montage ohne lochbohrung: material mit doppel-, silikon- oder 2-komponenten-kleber direkt auf dem kopf befestigen. material: transparentes polycarbonat bzw. farbiges oder verchromtes nylon. wandabstand: 21mm. plattenstärke: bis max. 12mm.

EN variable grid-clampsystem. wallmount the spacer, put the head through the panel and snap in the spacer. elastic small plates keep the panel solid seated. retractable stainless steel spring prevents from manipulation. fixxo white is available also with a flat head (FIXXO1621WEFL) for invisible mounting without holes: fix the panel with adhesive tape, silicone or superglue directly on the fixxo head. material: transparent polycarbonate resp. coloured or plated nylon. wall distance: 21mm. sign thickness: up to 12mm.

	nero satinato schwarz matt black matt	1box	pz/st/pc
	FIXXO1621MSZ	40pcs	
	grigio satinato grau matt grey matt FIXXO1621GR	40pcs	
	color vetro glasgrün glassgreen FIXXO1621GG	40pcs	
	bianco weiss white FIXXO1621WE	40pcs	
	FIXXO1621WEFL	40pcs	

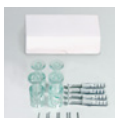

peso

MADE IN EU design by KD

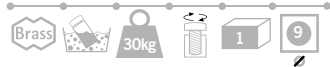
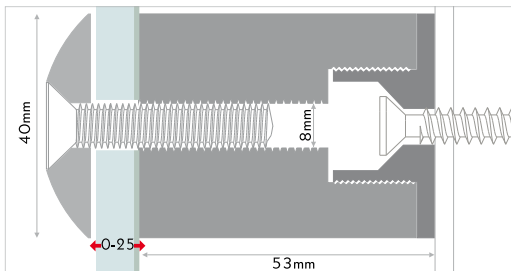

IT sistema di fissaggio per lastre di grandi dimensioni e spesse, adatto anche per l'utilizzo in ambienti architettonici. fissaggio: sistema di fissaggio a vite, montaggio frontale. materiale: ottone cromato, vite a brugola in acciaio inox, rondelle in poliuretano.

DE schraubensystem für grossformatige und schwere paneele, auch im architektonischen bereich. befestigung: schraubensystem, frontale montage. material: messing veredelt, inbusschraube edelstahl, PUR-beilagscheiben.

EN screwsystem for large-format and heavy panels. especially used also in the range of architecture. mounting: screw system, frontal mounting. material: plated brass, stainless steel allen screw, PUR washer.

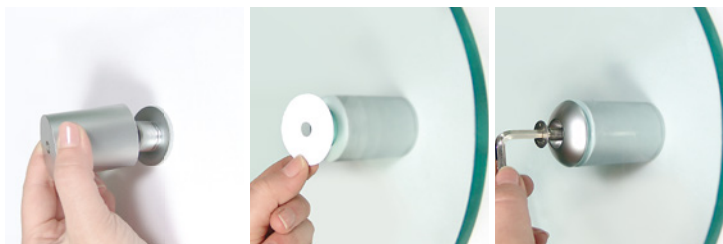

cromo | chrom | chrome

FPESO4053CM

1pc

pz/st/pc

argento | silber | silver

FPESO4053AR

1pc

maxi

patented

MADE IN EU design by KD

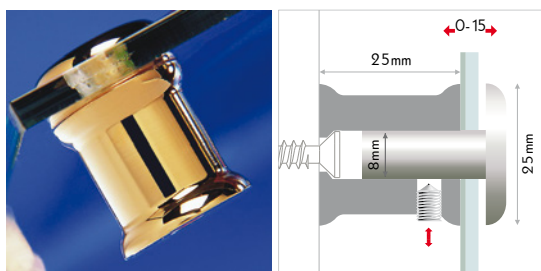

IT sistema di fissaggio con chiusura di sicurezza per grandi formati. fissare il distanziale alla parete, posizionare il pannello, inserire la testina nel foro e attraverso il pannello e completare il fissaggio tramite la brugola laterale di sicurezza, che impedisce che la targa possa venir manomessa o smontata. per lastre, targhe e pannelli di grandi dimensioni e spessori. fissaggio: sistema di fissaggio con chiusura laterale di sicurezza, a prova di manomissioni. materiale: ottone con cromatura della superficie.

DE stecksystem mit arretierung für grosse formate. halter an der wand befestigen, material auflegen, kopf durch das paneel in den halter stecken und mit seitlicher madenschraube im halter gegen manipulation sichern. für grossflächige schilder, platten, paneele und borde höherer stärke. befestigung: stecksystem mit arretierung, manipulationssicher. material: messing oberflächenveredelt.

EN plug-interlocksystem for big sizes. mount the fastener to the wall, put on the panel and plug the head through the panel into the fastener. fix the head in the fastener with the allen screw. for signs, panels and boards with bigger size. mounting: plug-interlocksystem, tamper-proof. material: plated brass.

combinations

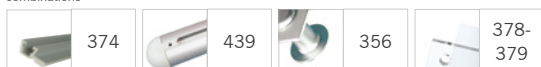

	cromo chrom chrome		1box	pz/st/pc
	FM2525CM	20pcs		
	FM2525AR	20pcs		
	FM2525GD	20pcs		

corner

MADE IN EU design by KD

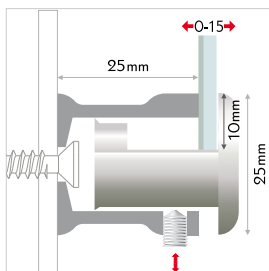

Brass 5kg 20

IT sistema di fissaggio angolare con chiusura di sicurezza, senza fori. materiale: ottone con cromatura.

DE Eckhalter, klemmsystem mit arretierung, ohne bohrung und manipulationsgeschützt. material: messing veredelt.

EN corner fastener without hole, clamp-interlocksystem, tamper-proof. material: plated brass.



combinations

	374		439		356		378-379
--	-----	--	-----	--	-----	--	---------

	romo chrom chrome	1 box	pz/st/pc
	FC2525CM	20pcs	
	argento silber silver		
	FC2525AR	20pcs	
	oro gold gold		
	FC2525GD *	20pcs	

* fino ad esaurimento scorte | solange vorrat reicht | while stock last

border

MADE IN EU design by KD

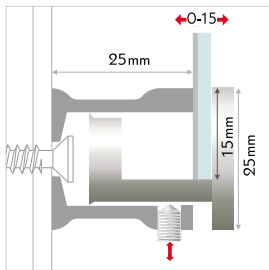

Brass 5kg 20

IT sistema di fissaggio laterale con chiusura di sicurezza., senza fori. materiale: ottone con cromatura

DE randhalter klemmsystem, ohne bohrung, manipulationsgeschützt. material: messing veredelt.

EN border fastener clamp system, tamper-proof, no holes. material: plated brass.



combinations

	374		439		356		378-379
--	-----	--	-----	--	-----	--	---------

	romo chrom chrome	1 box	pz/st/pc
	FB2525CM	20pcs	
	argento silber silver		
	FB2525AR	20pcs	

distanziali a parete | wandmontiert | on the wall

fisso



safe

MADE IN EU design by KD

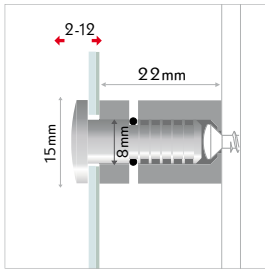

IT sistema variabile zigrinato, chiusura di sicurezza, veloce da montare. prima del montaggio inserire le testine nel pannello e le rondelle in pvc, montare i distanziali alla parete. le rondelle assicurano un fissaggio perfetto del pannello. premere il pannello con le testine nei fori dei distanziali. inserire la moletta per bloccare la testa contro la manipolazione. per lastre, targhe e pannelli di spessore medio. montaggio semplice e veloce. fissaggio: sistema zigrinato, con chiusura laterale di sicurezza. materiale: acciaio inox o ottone color cromo lucido o argento satinato.

DE variables raster-klemmsystem, manipulationsgeschützt und schnell. köpfe vor der montage durch das paneel und die pvc-scheibe stecken, hülssen an der wand befestigen. pvc-scheiben sorgen für satte auflage und halten die köpfe im paneel. köpfe dann einfach aufklicken. metallklemme einschieben und das paneel im halter gegen manipulation sichern. für schilder, platten, paneele und borde mittlerer stärke, schnelle, bequeme montage. befestigung: raster-klemmsystem mit arretierung, manipulationsicher. material: edelstahl bzw. messing versilbert oder verchromt.

EN variable grid-clampsystem, tamper-proof, quickly mounted. put the head through panel and washer, wallmount the spacers. the weak pvc washer secures full bearing of the panel and also holds the heads in the panel before mounting. now plug the heads into the spacers and insert the spring for secure and tamper-proof hold. for signs, panels and boards with medium size, mounting is quick and convenient. mounting: variable grid-clampsystem, tamper-proof. material: stainless steel or brass, silver- or chrome-plated.



combinations

	420		485
	396		467
	425		425

	cromo chrom chrome	FSF1520CM	40pcs	1box	pz/st/pc
	argento silber silver	FSF1520AR	40pcs		
	acciaio stahl steel	FSF1520IX	40pcs		

fast MADE IN EU design by KD

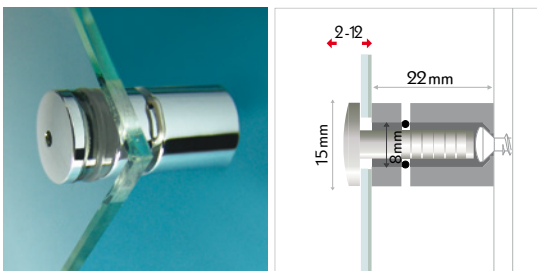

IT sistema variabile zigrinato, chiusura di sicurezza frontale, veloce. montare i distanziali alla parete, inserire la moletta. inserire le testine nel pannello e le rondelle in pvc. le rondelle assicurano un fissaggio perfetto del pannello. premere il pannello con le testine nei fori dei distanziali. per fissare avvitare le testine di 90°. il fissaggio è anche possibile centrale nel pannello grazie al sistema di fissaggio frontale tramite la testina.

DE variables raster-drehsystem, frontale sicherung, schnell. hülse wandmontieren, feder einschieben. köpfe durch das panel und die pvc-scheibe stecken, pvc-scheiben sorgen für satte auflage. köpfe dann einfach aufklicken und mit 90° dreh sichern. verwendung auch mittig in paneelen möglich, da die sicherung mit dem kopf selbst und nicht der hülse erfolgt.

EN variable grid-turnsystem, frontal lock, quick. wallmount the spacers, insert the spring. put the head through panel and washer. the weak pvc washer secures full bearing of the panel. now plug the heads into the spacers and rotate the heads 90° for locking. thanks to the frontal locking system with the head, the mounting in the center of panels is possible.

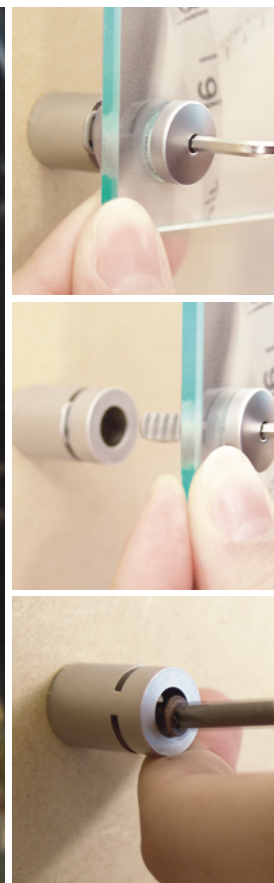
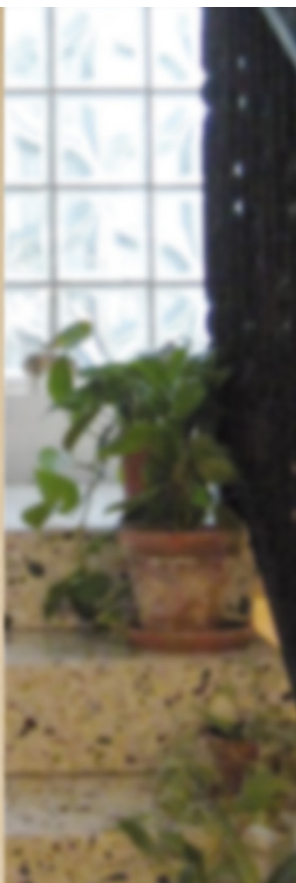
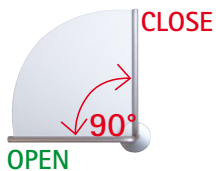

combinations

	420		485
	396		467
	424-425		

	cromo chrom chrome	1box	pz/st/pc
	FFA1320CM	40pcs	
	argento silber silver		
	FFA1320AR	40pcs	

rapid

patented

MADE IN EU design by KD

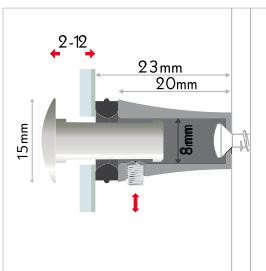

IT rivoluzionario sistema di fissaggio con chiusura di sicurezza. solo pochi giri saranno sufficienti per allargare la testina ed assicurare la targa sul distanziale. completo di rondelle „cuscinetto“ elastiche. materiale: zamac in diverse finiture.

DE revolutionäres steck-klemmsystem mit manipulationschutz. dank speziellen designs genügen wenige umdrehungen der madenschraube, der halter wird in der hülse aufgespreizt und gesichert. elastische beilagscheiben für satte auflage. veredelter metalledruckguss.

EN revolutionary tamperproof plug interlock system. just few turns of the allen screw will spread the head pin, fastening the panel to the standoff. elastic washers for a tighter fit. material: plated die-cast metal.

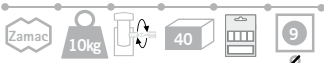

facile da usare, semplice e veloce: completi di grano già nella sua sede

anwenderfreundlich, einfach und zeitsparend: vormontierte madenschraube.

user-friendly, hassle-free and time saving: pre-assembled allen screw



design intelligente: pochi giri del grano allargano la testina, semplice e sicuro.

cleveres design: halter wird in der hülse mit wenigen umdrehungen gesichert.

clever design: head is spread with few turns in the spacer, fixing the panel safely



		1 box	pz/st/pc
	cromo chrom chrome FRA1520CM	40pcs	
	argento silber silver FRA1520AR	40pcs	
	oro gold gold FRA1520GD	40pcs	
	rame satinato kupfer matt matt copper FRA1520MCO	40pcs	
	steel look steel look steel look FRA1520IX	40pcs	
	bronzo veneziano bronze veneziano venetian brass FRA1520VB	40pcs	

combinations



three | four | six

MADE IN EU design by KD

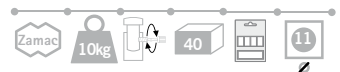
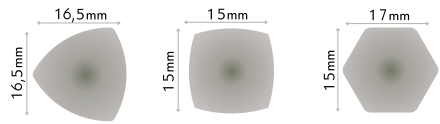
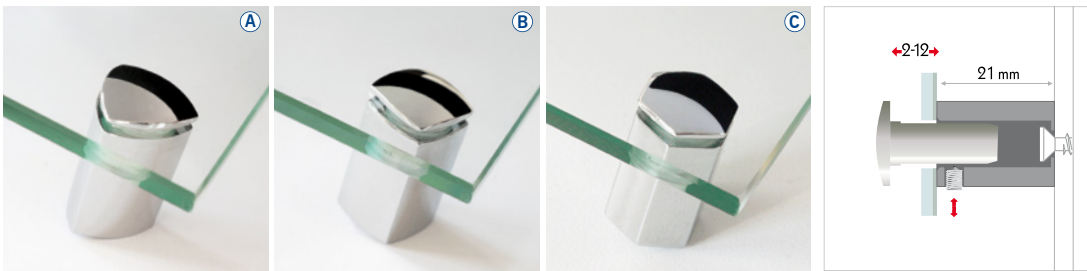

IT fisso three, fisso four o fisso six vi offrono un design stravagante e particolare: in metallo pregiato e disponibili nei colori più attuali, sono i veri e propri gioielli della linea fisso. fissaggio con grano laterale a prova di manomissione.

DE extravagant und ganz besonderes design bieten fisso three, fisso four oder fisso six: aus hochwertigem metalldruck guss und in topaktuellen farben sind sie die schmuckstücke der fisso linie. stecksystem mit manipulationsschutz und fallsicherung.

EN fancy and a very special design you find with fisso three, fisso four and fisso six: made of high-grade die cast metal and in up-to-date finishes these fixings are the real gems of the fisso line. tamper-proof plug-system with fall arrester.



	Cromo chrom chrome	1box	pz/st/pc
A	FFT1621CM	40pcs	
B	FFF1621CM	40pcs	
C	FFS1621CM	40pcs	
	argento silber silver		
A	FFT1621AR	40pcs	
B	FFF1621AR	40pcs	
C	FFS1621AR	40pcs	
	oro gold gold		
A	FFT1621GD	40pcs	
B	FFF1621GD	40pcs	
C	FFS1621GD	40pcs	

	rame satinato kupfer matt matt copper	1box	pz/st/pc
A	FFT1621MCO	40pcs	
B	FFF1621MCO	40pcs	
C	FFS1621MCO	40pcs	
	steel look steel look steel look		
A	FFT1621IX	40pcs	
B	FFF1621IX	40pcs	
C	FFS1621IX	40pcs	
	bronzo veneziano bronze veneziano venetian brass		
A	FFT1621VB	40pcs	
B	FFF1621VB	40pcs	
C	FFS1621VB	40pcs	

cubix

MADE IN EU design by KD

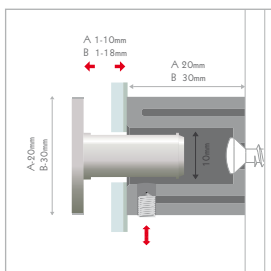
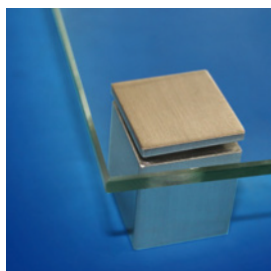

NEW PRODUCT

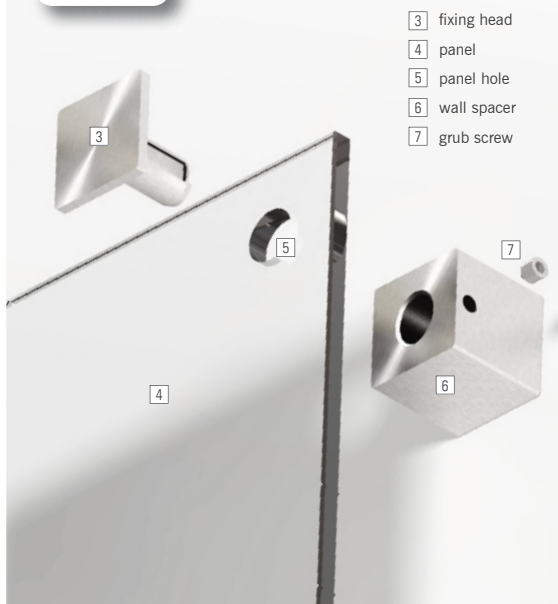

IT semplice e elegante! cubix propone un design moderno ed elegante al cubo! il distanziatore è realizzato in metallo pressofuso di alta qualità con effetto di acciaio spazzolato. cubix convince grazie alla testina super sottile e al sistema antifurto realizzato tramite una brugola che garantisce la chiusura di sicurezza. cubix è realizzato in materiale resistente agli agenti atmosferici e quindi è perfetto sia per l'uso interno che esterno.

DE einfach und elegant. cubix das ist modernes design in würfelform: der extra flache kopf passt sich perfekt an jedes paneel an. der hochwertige metalldruckguss in gebürsteter edelstahl optik sieht nicht nur gut aus, er ist auch langlebig und robust. das praktische stecksystem mit manipulationsschutz verfügt über eine zusätzliche sicherung, die den kopf auch bei loser madenschraube in der wandhülse hält. mit cubix treffen sie eine stilsichere wahl für das elegante ambiente!

EN simple and elegant! cubix represents modern design in a special form: the extra flat head matches perfectly with every kind of panels. the high-grade metal die-cast in brushed steel look is not only longliving and robust but also really good-looking. the convenient and tamper-proof plug-interlock system has a extra covering that will prevent the head from falling down even with a loose grub screw. choose cubix you show a sense of taste for the elegant ambience!

information

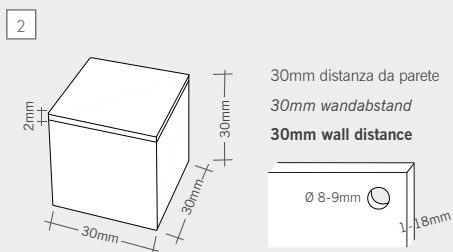
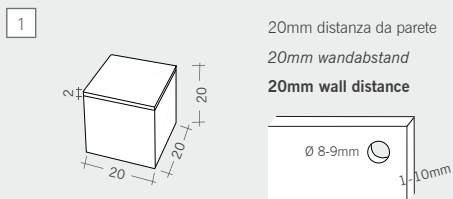

materiale: metallo pressofuso
superficie impreziosita dall'effetto di acciaio spazzolato

material: metalldruckguss
veredelte oberfläche in gebürsteter edelstahl optik

material: die-cast metal
surface finish with brushed steel look



cubix

			1 box	pz/st/pc
1	FCB2020IX	cubix 20x20mm, inox, 40pc		
2	FCB3030IX	cubix 30x30mm, inox, 20pc		



fissare il distanziale alla parete
wandhülse wandmontieren
mount the spacer to the wall

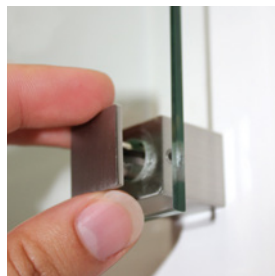

posizionare il pannello, inserire la testina nel foro e attraverso il pannello
paneel auflegen und kopf durch das paneel in den halter stecken

put on the panel and plug the head through the panel into the fastener

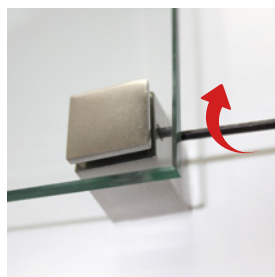

mit seitlicher madenschraube im halter gegen manipulation sichern

completare il fissaggio tramite la brugola laterale di sicurezza

fix the head in the fastener with the grub screw

advantages

- ✓ testina super sottile
extra flacher kopf
extra slim head
- ✓ sistema antifurto
manipulationsschutz
anti-theft system
- ✓ chiusura di sicurezza
fallsicherung für den kopf
fall arrester for head
- ✓ montaggio veloce grazie alla brugola premontata
schnelle montage durch vormontierte madenschrauben
fast mounting thanks to pre-assembled grub screws

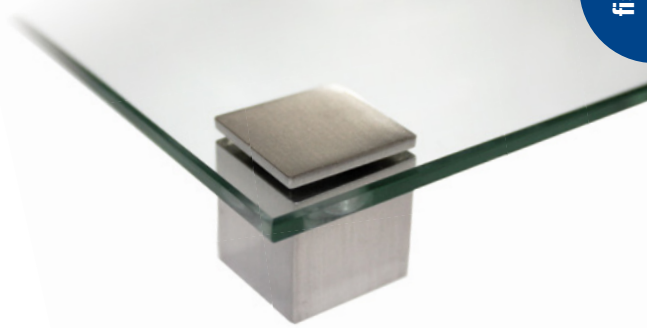



mix alu

MADE IN EU design by KD

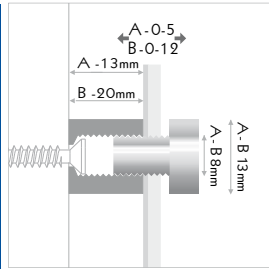

IT elegante sistema a vite in alluminio. montare il distanziale a muro e, dopo aver posizionato la targa, avvitare la testina sul distanziale. la testina è dotata di un forellino laterale che ne facilita l'avvitamento. a prova di impronte digitali. fissaggio: sistema a vite, montaggio frontale. materiale: alluminio anodizzato in color argento, oro, nero e titanio.

DE elegantes schraubensystem aus alu. halter wandmontieren, kopf durch das paneel in den halter schrauben. seitliche lochbohrung für verschrauben des kopfes. fingerabdruck-resistent. befestigung: schraubensystem, frontale montage. material: matt eloxiertes aluminium in silber, gold, schwarz und titan.

EN elegant aluminium screwsystem. wallmount the fastener, screw the head through the sign into the fastener. head with lateral hole for easy screwing. fingermark-proof. mounting: screw-system, frontal mounting. material: satin anodized aluminium in silver, gold, black and titan.

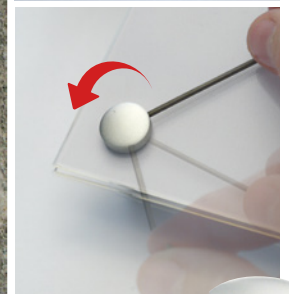
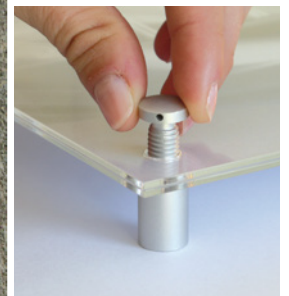
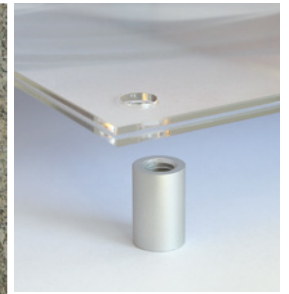
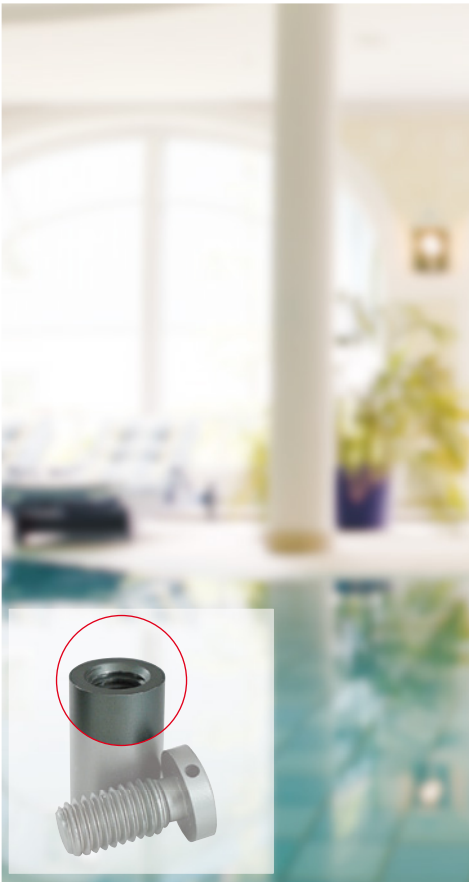

argento | silber | silver 1box pz/st/pc

A: FMX1313AL 40pcs

B: FMX1320AL 40pcs

nero | schwarz | black

FMA1320MSZ 40pcs

oro | gold | gold

FMA1320MGD 40pcs

titanio | titan | titan

FMA1320TI 40pcs

combinations

	420		424-425
--	-----	--	---------



mix alu

MADE IN EU design by KD

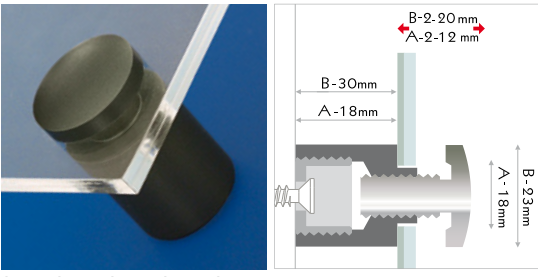

IT sistema di fissaggio a vite per grandi pannelli che offre una maggiore distanza dal muro. specifica conformazione per un facile posizionamento del pannello. resistente alle impronte lasciate dalle dita. fissaggio: sistema di fissaggio a vite, montaggio frontale. materiale: alluminio anodizzato in oro, argento, nero e titanio.

DE schraubsystem für grössere paneele mit mehr wandabstand. hülsenhalb für leichtes positionieren des paneels. fingerabdruck-resistent. befestigung: schraubsystem, frontale montage. material: matt eloxiertes aluminium in silber, gold, schwarz und titan.

EN aluminium screw system for bigger panels with more distance to the wall. easy positioning of the panel thanks to the neck on the wall support. fingermark proof. mounting: screw system, frontal mounting. material: satin anodized aluminium in silver, gold, black and titan.

AI 15kg A: 40 B: 20 11 4 4



argento silber silver		1box	pz/st/pc
A: FMA1818AR	40pcs		
B: FMA2330AR	20pcs		
nero schwarz black			
A: FMA1818MSZ	40pcs		
B: FMA2330MSZ	20pcs		
oro gold gold			
A: FMA1818MGD	40pcs		
B: FMA2330MGD	20pcs		
titanio titan titan			
A: FMA1818TI	40pcs		
B: FMA2330TI	20pcs		

distanziali a parete | wandmontiert | on the wall

fisso



mix

MADE IN EU design by KD



IT sistema di fissaggio a vite – una vasta scelta. fisso mix offre la soluzione piú pratica per il fissaggio di lastre in posti poco accessibili come nicchie o angoli interni. fissare il distanziale alla parete, posizionare il pannello, inserire la testina nel foro e attraverso il pannello e avvitare per completare il fissaggio. materiale: ottone con cromatura

DE schraubsysteme - die grosse auswahl. fisso mix bietet die praktische lösung plattenmaterial an schwer zugänglichen orten wie nischen oder innenecken zu montieren. halter wandmontieren, kopf durch das panel stecken und in den halter schrauben. material: messing oberflächenveredelt

EN screwsystems - a wide choice. fisso mix is the convenient choice when you have to mount panels in niches and corners that are hard to reach. wallmount the fastener, put the head through the sign and screw it into the fastener. material: plated brass



diametro | Durchmesser | diameter
 distanza muro | wandabstand | wall distance
 foro | gewinde | thread
 colore | farbe | colour

FMX 13 19M8GD

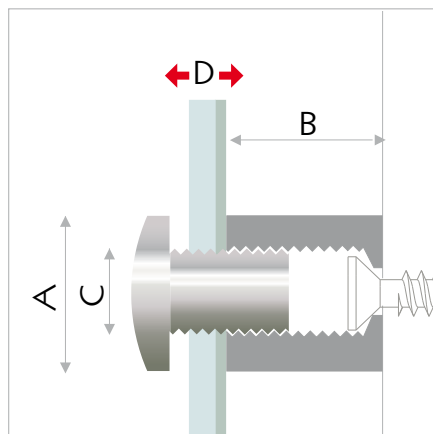

oro gold gold		1 box	pz/st/pc
FMX1313M8GD	40pcs		
romo chrom chrome			
FMX1313M8CM	40pcs		
argento silber silver			
FMX1313M8AR	40pcs		

	A	B	C	D
FMX1313	13	13	8	5



oro gold gold		1 box	pz/st/pc
FMX1319M8GD	40pcs		
romo chrom chrome			
FMX1319M8CM	40pcs		
argento silber silver			
FMX1319M8AR	40pcs		

	A	B	C	D
FMX1319	13	19	8	10



romo chrom chrome		1 box	pz/st/pc
FMX1925M12CM	20pcs		
argento silber silver			
FMX1925M12AR	20pcs		

	A	B	C	D
FMX1925	19	25	12	14

combinations

	420		485		424-425
--	-----	--	-----	--	---------



cromo chrom chrome	1box	pz/st/pc
FMX1930M12CM	20pcs	
argento silber silver		
FMX1930M12AR	20pcs	



	A	B	C	D
FMX1930	19	30	12	18



cromo chrom chrome	1box	pz/st/pc
FMX2530M12CM	20pcs	
argento silber silver		
FMX2530M12AR	20pcs	



	A	B	C	D
FMX2530	25	30	12	18



oro gold gold	1box	pz/st/pc
FMX2550M12GD*	10pcs	
cromo chrom chrome		
FMX2550M12CM	10pcs	
argento silber silver		
FMX2550M12AR	10pcs	



	A	B	C	D
FMX2550	25	50	12	25

* fino ad esaurimento scorte | solange vorrat reicht | while stock last



cromo chrom chrome	1box	pz/st/pc
FMX3030M12CM	10pcs	
argento silber silver		
FMX3030M12AR	10pcs	



	A	B	C	D
FMX3030	30	30	12	15



oro gold gold	1box	pz/st/pc
FMX3060M12GD*	10pcs	



	A	B	C	D
FMX3060	30	60	12	30

* fino ad esaurimento scorte | solange vorrat reicht | while stock last



oro gold gold	1box	pz/st/pc
FMX4040M12GD	6pcs	
cromo chrom chrome		
FMX4040M12CM	6pcs	
argento silber silver		
FMX4040M12AR	6pcs	



	A	B	C	D
FMX4040	40	40	12	25



oro gold gold	1box	pz/st/pc
FMX4080M12GD*	6pcs	



	A	B	C	D
FMX4080	40	80	12	30

* fino ad esaurimento scorte | solange vorrat reicht | while stock last



distanziali a parete | wandmontiert | on the wall

fisso



steel 13

MADE IN EU design by KD

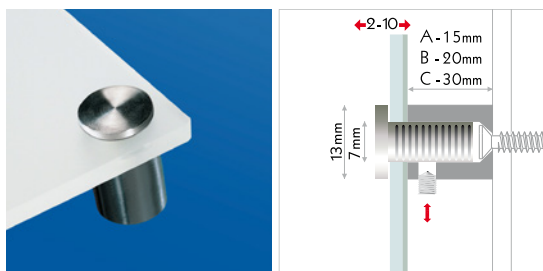

IT sistema di fissaggio in acciaio con chiusura laterale di sicurezza per piccoli formati. fissare il distanziale alla parete, posizionare il pannello, inserire la testina nel foro e attraverso il pannello e completare il fissaggio tramite la brugola laterale di sicurezza, che impedisce che la targa possa venir manomessa o smontata. materiale: acciaio inox AISI304, testina con sfaccettature.

DE hochwertiger edelstahl, elegante facettentoptik, stecksystem mit manipulationsgeschützter arretierung für kleine formate. halter an der wand befestigen, paneel auflegen, kopf durch das paneel in den halter stecken und mit seitlicher madenschraube im halter gegen manipulation sichern. material: edelstahl AISI304, facetteneffekt.

EN high-quality stainless steel, elegant facet appearance, plug-interlocksystem, tamper-proof, for small sizes. mount the fastener to the wall, put on the panel and plug the head through the panel into the fastener. fix the head in the fastener with the allen screw. material: stainless steel AISI304, head with facet cut.



combinations



acciaio stahl steel		1box	pz/st/pc
A: FS1315IX	40pcs		
B: FS1320IX	40pcs		
C: FS1330IX	20pcs		

steel 15

MADE IN EU design by KD

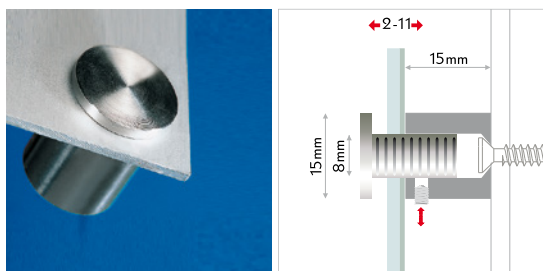

IT sistema di fissaggio in acciaio con chiusura laterale di sicurezza per piccoli formati. fissare il distanziale alla parete, posizionare il pannello, inserire la testina nel foro e attraverso il pannello e completare il fissaggio tramite la brugola laterale di sicurezza, che impedisce che la targa possa venir manomessa o smontata. materiale: acciaio inox AISI304, testina con sfaccettature

DE hochwertiger edelstahl, elegante facettentoptik, stecksystem mit manipulationsgeschützter arretierung für kleine formate. halter an der wand befestigen, paneel auflegen, kopf durch das paneel in den halter stecken und mit seitlicher madenschraube im halter gegen manipulation sichern. material: edelstahl AISI304, facetteneffekt

EN high-quality stainless steel, elegant facet appearance, plug-interlocksystem, tamper-proof, for small sizes. mount the fastener to the wall, put on the panel and plug the head through the panel into the fastener. fix the head in the fastener with the allen screw. material: stainless steel AISI304, head with facet cut.



combinations

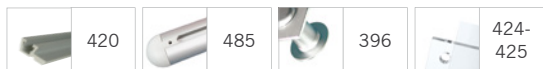

acciaio stahl steel		1box	pz/st/pc
FS1515IX	40pcs		

steel 20

MADE IN EU design by KD

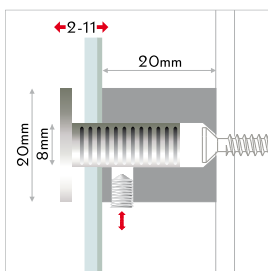
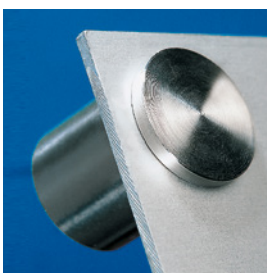

IT sistema di fissaggio in acciaio con chiusura laterale di sicurezza per formati medie. materiale: acciaio inox AISI304, testina con sfaccettature.

DE edelstahl-stecksystem mit manipulationsgeschützter arretierung, für mittlere formate. material: edelstahl AISI304, facetteneffekt.

EN stainless steel, plug-interlocksystem for middle sizes, tamper-proof. material: stainless steel AISI304, head with facet cut

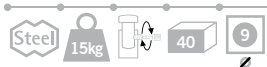

combinations

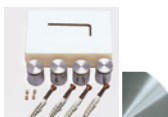
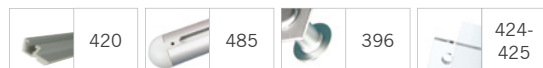

acciaio | stahl | steel

FS2020IX

40pcs

1 box

pz/st/pc

steel 25

MADE IN EU design by KD

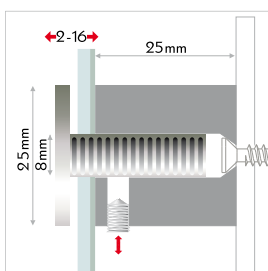
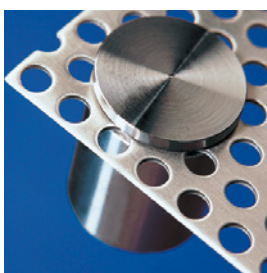

IT fissaggio in acciaio con chiusura laterale di sicurezza per formati grandi. materiale: acciaio inox AISI304, testina sfaccettata.

DE edelstahl-stecksystem mit manipulationsgeschützter arretierung für grosse formate. material: edelstahl AISI304, facetteneffekt.

EN stainless steel, plug-interlocksystem for big sizes, tamper-proof. material: stainless steel AISI304, head facet cut.

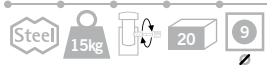
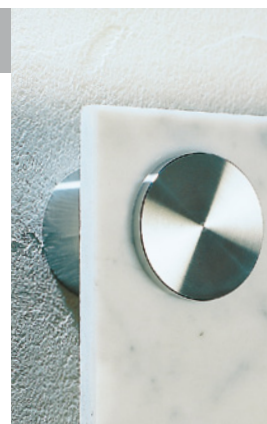

combinations

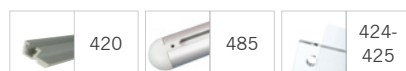

acciaio | stahl | steel

FS2525IX

20pcs

1 box

pz/st/pc

steel 50

MADE IN EU design by KD

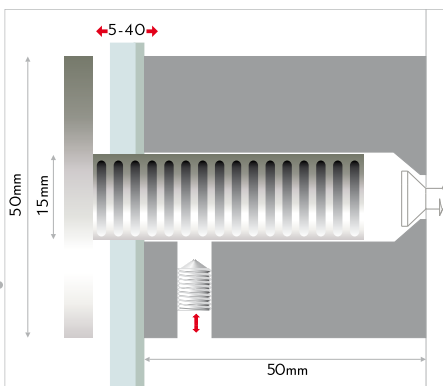
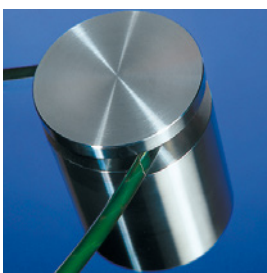

IT sistema di fissaggio in acciaio con chiusura laterale di sicurezza per lastre spesse e pesanti. materiale: acciaio inox AISI304, testina con sfaccettature.

DE stecksystem mit arretierung, edelstahl mit facettenoptik, für dicke, schwere paneele, manipulationsgeschützt. material: edelstahl AISI304, facetteneffekt.

EN plug-interlocksystem, faceted stainless steel for thick and heavy panels, tamper-proof. material: stainless steel AISI304, head facet cut.

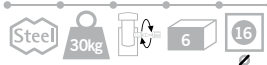

combinations

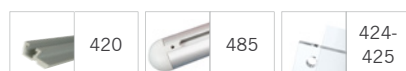

acciaio | stahl | steel

FS5050IX

1pc

pz/st/pc

clamper

MADE IN EU design by KD

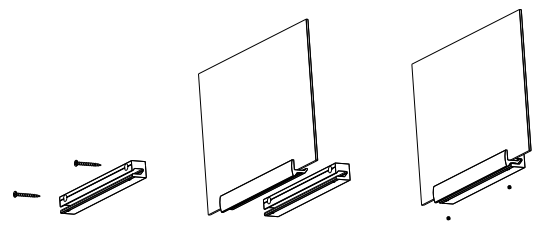
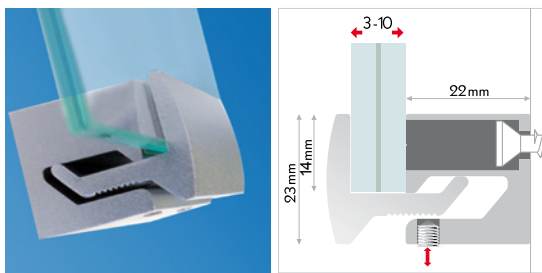

IT elegante sistema ad incastro, privo di fori. montare un profilo alla parete, agganciare l'altro profilo, inserire il pannello e fissarlo con i grani. pannelli di spessore diverso potranno essere assicurati senza bisogno di fori. clamper può essere usato in diverse lunghezze, mono -o bifacciale, per sistemi a sandwich o per singoli pannelli. abbiamo raggruppato per voi pannelli di vetro temperato nei formati più comuni. materiale: alluminio anodizzato argento.

DE variables klemmsystem, ohne bohrung. ein profil wandmontieren, das zweite einhaken, paneel auflegen und mit madenschrauben fixieren. paneele diverser stärken werden ohne bohrung sicher befestigt. sie können clamper in verschiedenen längen, ein- oder mehrseitig, im sandwichsystem oder mit einzelpaneelen verwenden. befestigung: klemmsystem ohne bohrung, manipulationssicher. material: silber eloxiertes aluminium. .

EN elegant clamp system, no holes. wall mount one profile, hook in the second, put on the panel and fix with allen screws. panels of different thicknesses are safely fastened without holes. you can use clamper in different lengths, on one or two sides, as sandwich system or with single panels. we provide you also with tempered glass panels in the most common sizes. mounting: variable clampssystem, tamper-proof. material: silver anodized aluminium.



clamper		pz/st/pc
FCL60	clamper, 60mm,1pc	
FCL100	clamper, 100mm,1pc	
FCL200	clamper, 200mm,1pc	
FCL300	clamper, 300mm,1pc	
FCL400	clamper, 400mm,1pc	
FCL600	clamper, 600mm,1pc	
FCL900	clamper, 900mm,1pc	
FCL2000	clamper, 2000mm,1pc	

tempered glass		pz/st/pc
FCL150150VE	glass, 150x150x4mm,1pc	
FCL150300VE	glass, 150x300x4mm,1pc	
FCL300450VE	glass,300x450x4mm,1pc	
FCL450600VE	glass, 450x600x4mm,1pc	
FCL200200VE	glass, 200x200x4mm,1pc	
FCL200400VE	glass, 200x400x4mm,1pc	
FCL250250VE	glass, 250x250x4mm,1pc	
FCL170370VE	glass, 170x370x4mm,1pc	

clamper support

MADE IN EU design by KD

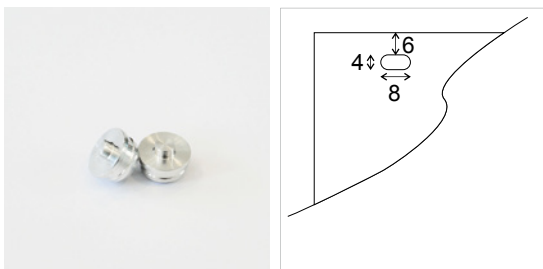

la distanza dei fori nel fisso clamper può variare, quindi prima di forare il pannello si prega di prendere le misure direttamente con il fisso clamper utilizzato.

abstände der bohrungen bei fisso clamper, können variieren, daher masse für panelbohrung direkt bei den verwendeten fisso clamper abnehmen.

the distance of the holes on fisso clamper can vary, therefore check the distance for panel holes directly with the fisso clamper used.

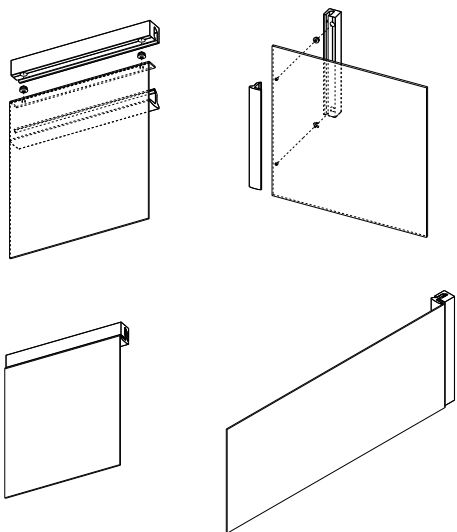

IT per il fissaggio perpendicolare di pannelli singoli, clamper support si fissa facilmente inserendo la lastra nei fori predisposti. se usato in combinazione con pannelli debitamente piegati e con clamper, potete creare anche della segnaletica a bandiera o a soffitto. materiale: alluminio.

DE für die senkrechte befestigung von einzelpaneelen, clamper support einfach in die lochbohrungen einsetzen. mit entsprechend gebogenen paneelen können sie clamper mit dem clamper support auch für decken- oder fahnschilder einsetzen. material: aluminium.

EN for the upright mounting of single panels you can simply insert the clamper support into the holes. clamper support even turns your clamper with shaped panels into a flag or ceiling sign support. material: aluminium.



acciaio | stahl | steel

FCL02AL

clamper support, 2pcs



unico

MADE IN EU design by KD

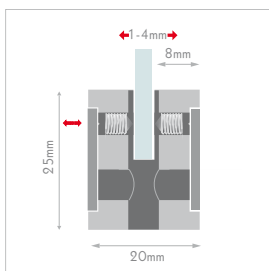

IT universale, innovativo e velocissimo: fisso unico – tutto in uno! con il sistema di fissaggio unico è possibile trasformare qualsiasi pannello in un cartello a soffitto, a bandiera, a parete e su qualsiasi supporto orizzontale. il sostegno in plastica è adatto per pannelli di vari materiali: basta inserire il pannello nel supporto nel modo che si desidera, fissarlo con una vite senza testa e fare una leggera pressione sulle cover. unico è un sistema conveniente perfetto per qualsiasi cartello.

DE universell, innovativ und schnell: fisso unico - einer für alles! mit dem befestigungssystem unico können sie paneele zu decken-, fahnen-, top- oder türschildern machen. in den kunststoffhalter spannen sie paneele unterschiedlicher materialien ein: legen sie das pannel je nach montageart in die halterung ein, fixieren sie es mit madenschrauben und klicken dann die abdeckkappen auf. mit dem kostengünstigen unico system sind ihrer beschilderung kaum grenzen gesetzt.

EN universal, innovative and quick. fisso unico - one for all! with the fixing system unico you can turn your panels into ceiling, flag, top or door signs. the white support can hold panels of different materials: insert the panel according to the choosen version into the support, fix it with the grub screws in place and then click on the covers. with the economic unico supports your signage is well placed.



la dimensione massima del cartello dipende dalla rigidità e dal peso del pannello.

max. plattengröße abhängig von steifigkeit und gewicht des paneels

max. panel size dependson stiffness and weight of the panel

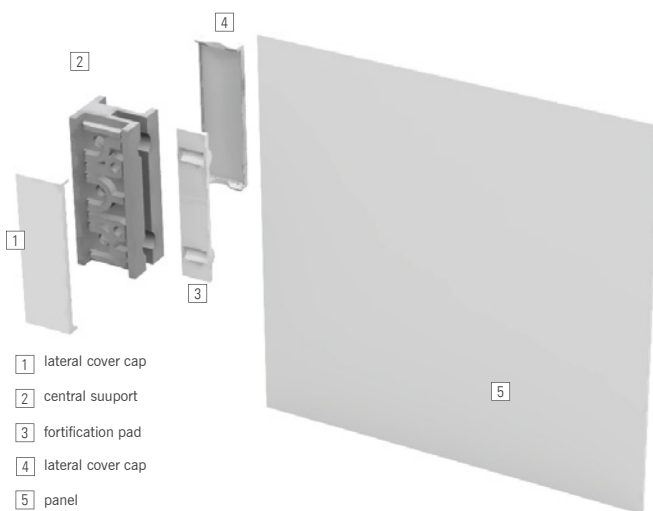
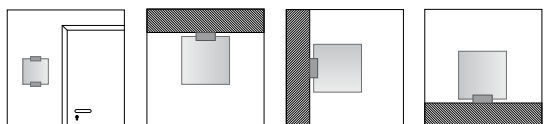

- 1 lateral cover cap
- 2 central support
- 3 fortification pad
- 4 lateral cover cap
- 5 panel

information

• materiale: plastica bianca, cover in argento opaco

material: kunststoff, weiß, abdeckungen in silber matt

synthetic in white, side caps silver matt

• capacità di carico: max 5kg, per materiali rigidi come vetro o pietra utilizzare solo come cartelli a porta/a parete.

traglast: max. 5kg, für harte materialien wie glas oder stein nur als türschild einsetzen

max. load 5kg, for hard materials such as glass or stone use only as door sign

• spessore massimo del pannello: 4mm. per pannelli di spessore maggiore, è incluso anche un supporto di rafforzamento.

paneelstärke max. 4mm, für paneele <4mm verstärkungsplättchen inkl.

panel thickness max. 4mm, for panels <4mm fortification pad incl.

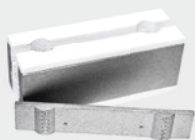
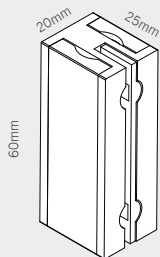

unico

FUC6025AR

20pcs

1box

pz/st/pc



montare il supporto per il pannello alla parete.
paneelhalterung wandmontieren
wallmount the panel support

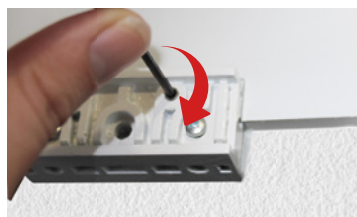

inserire il pannello, eventualmente anche il supporto di rafforzamento, fissare con una vite senza testa.
paneel einsetzen, evtl. verstärkung dazu, mit madenschrauben fixieren

insert panel, in case add the fortification pad, fix with grub screw



applicare la cover con una leggera pressione.
abdeckung einfach aufklicken
simply click on the covers



montare il supporto per il pannello alla parete.
paneelhalterung wandmontieren
wallmount the panel support

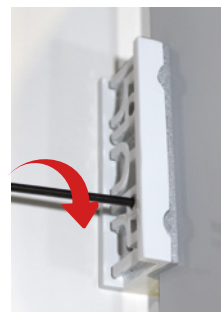

inserire il pannello, eventualmente anche il supporto di rafforzamento, fissare con una vite senza testa.
paneel einsetzen, evtl. verstärkung dazu, mit madenschrauben fixieren

insert panel, in case add the fortification pad, fix with grub screw

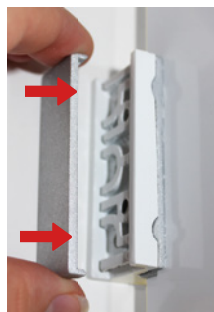

applicare la cover con una leggera pressione.
abdeckung einfach aufklicken
simply click on the covers

advantages

- 
 sistema di fissaggio innovativo e universale
innovatives, universelles befestigungssystem für schilder
innovative and universal mounting system for signs
- 
 4 possibilità di utilizzo: a soffitto, a bandiera, a parete, su supporti orizzontali
4 einsetzungsmöglichkeiten: decken-, fahnen-, top- oder türschild
4 possible application: ceiling, flag, top or door sign
- 
 perfetto per tutti i tipi di pannelli leggeri
perfekt für alle arten von leichten paneelen
perfect for all kinds of lightweight panels
- 
 per pannelli senza fori
für paneele ohne lochbohrung
for panels without holes

clip rail

MADE IN EU design by KD

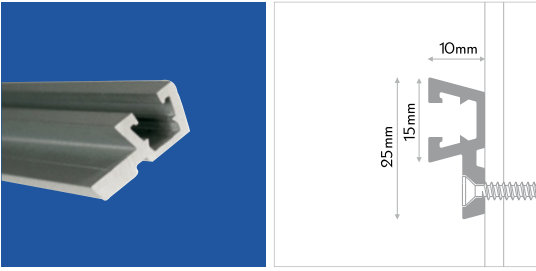

IT il pratico binario per il montaggio è dotato di dadi che si possono inserire nella cava, con un semplice clic, anche dopo l'installazione. i dadi di materiali plastico si possono spostare verticalmente sul binario in qualsiasi momento, facendo risparmiare tempo e denaro. cliprail si rivela essenziale soprattutto in caso di montaggio di molte targhe o quando la segnaletica debba venir cambiata con frequenza: il binario rimane sempre posizionato dove è stato montato. è necessario forare la parete solo una volta, le targhe possono poi essere cambiate o spostate facilmente sullo stesso binario. realizzato in alluminio anodizzato.

DE die praktische montageschiene mit nutstein zum einfachen einklipsen auch nach erfolgter montage. die kunststoff-nutsteine lassen sich vertikal jederzeit verschieben. zeit- und kostensparend, dabei immer exakt positioniert ist cliprail einfach praktisch bei montage von mehreren paneelen oder wenn schilder häufiger gewechselt werden. die wandbohrungen müssen nur einmal gemacht und die schilder können leicht ausgetauscht werden. aus silber eloxiertem aluminium.

EN the convenient mounting rail with sliding blocks that you can easily clip in even after wall mount mounting. the synthetic sliding blocks can be positioned anytime. saves time and money and always perfect in position, cliprail is simply perfect when you mount more panels or you want to exchange signs more often. the holes in the wall you need to drilled only once and the plates can be exchanged easily. cliprail is made of anodized aluminium.

✓ pratico: dati in materiale plastico ad aggancio sul profilo
praktisch: nutstein zum einklipsen
handy: clip in thread nut

✓ flessibile: le targhe si possono spostare o cambiare a piacere
flexibel: jederzeit verschiebbar
flexible: movable anytime



alluminio | aluminium | aluminium pz/st/pc
FCR1400 clip rail, 1400mm



x-man

MADE IN EU design by KD

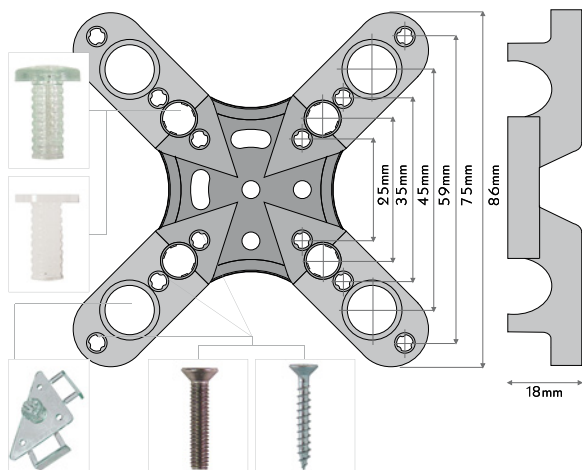

fissaggio di pannelli con viti.
panelbefestigung mit schrauben.
panel mounting with screws.

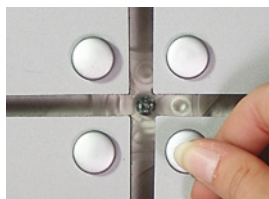

fissaggio di pannelli con il distanziale zigrinato fixxo.
panelbefestigung mit fixxo klicksystem.
panel mounting with fixxo click-in.

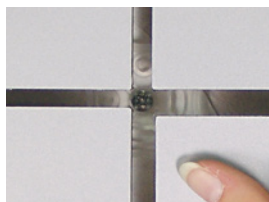

fissaggio invisibile di pannelli con ghost oppure con fixxo (FIXXK16WEFL).
unsichtbare panelbefestigung mit ghost oder fixxo (FIXXK16WEFL).
invisible panel mounting with ghost or fixxo (FIXXK16WEFL).

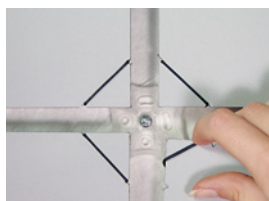

fissaggio dei pannelli con anellini di silicone.
panelbefestigung mit silikon-ringen.
panel mounting with silicone oring.

IT x-man: un talento nascosto. per il fissaggio di rivestimenti, pannelli, sistemi di informazione e molto di piú. il fissaggio puó essere visibile o invisibile, con viti, viti truciolari o con colla, fisso o rimovibile. ideale per luoghi di ingresso con molti pannelli o per pareti mobili. x-man puó essere montato centralmente o su un angolo. a seconda delle esigenze x-man puó essere usato in combinazione con i nostri distanziali e accessori. fissaggio: attacco a parete per viti, colla o a pressione. materiale: acrilico trasparente. nota bene: si prega di verificare se l'applicazione scelta è adatta per materiale e peso.

DE x-man: das multitalent im hintergrund. für die befestigung von verkleidungen, paneelen, informationssystemen und vielem mehr. befestigung sichtbar oder unsichtbar, mit schraube, holzschraube oder kleber, zum abnehmen oder fix montiert. ideal für eingangsbereiche mit vielen schildern oder für mobile wände. x-man kann zentriert oder auf eck montiert werden. kombinieren Sie x-man je nach bedarf mit unseren abstandhaltern und montagehilfen. befestigung: wandhalterung zum schrauben, kleben oder klicken. material: kunststoff, transparent. wichtiger hinweis: bitte testen sie die gewählte anwendung vorab auf eignung für material und gewicht.

EN x-man: allrounder in the background. for mounting of panelings, panels, information systems and much more. fastening is visible or invisible, with screw, woodscrew or glue, removable or fix. perfect for lobbies with a lot of signs or for mobile walls. you can mount x-man centered or on the corner. combine x-man according to your needs with our spacers and fit-up aids. mounting: wall holder for screwing, gluing or clicking. material: transparent synthetic. important note: please test in advance the chosen application if suitable for material and weight.



chiaro | klar | clear
FXMAN1885 2pcs 1box pz/st/pc



col. vetro | glasgrün | glassgreen
FIXXK16GG 40pcs



bianco | weiss | white
FIXXK16WEFL 40pcs



chiaro | klar | clear
FGK4618K 20pcs

combinations



wall-style

MADE IN EU design by KD

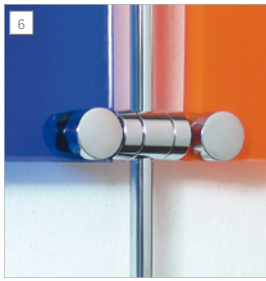
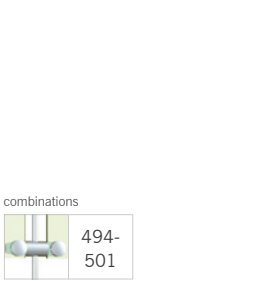
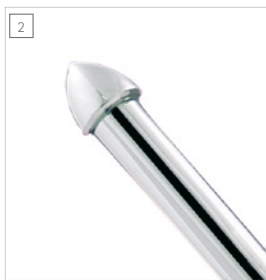
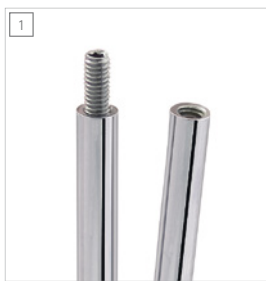

IT style, sistema di informazioni modulare a parete. regolare le astine del diametro di Ø6mm secondo la lunghezza desiderata. grazie alla combinazione dei due diversi formati (300mm e 400mm), è possibile variare la lunghezza del sistema a piacere, a partire da 600mm e in passi da 100mm. è possibile montare i pannelli frontalmente o lateralmente, grazie alla scelta dei distanziali. la lunghezza e la larghezza del sistema di informazioni sono variabili in qualsiasi momento grazie alla modularità degli elementi. materiale: ottone cromato lucido. distanza dalla parete: 18mm. spessore del pannello: max 10mm, spessori maggiori con brugole più lunghe. foro del pannello: Ø4mm.

DE style, modulares infosystem für die wand. die Ø6mm stangen je gewünschter länge verschrauben. durch kombination der von 300mm und 400mm sind ab 600mm alle längen in 100mm-schritten möglich. frontale oder seitliche paneelmontage je nach wahl des halters. jederzeit in länge und höhe erweiterbar durch die modulare bauweise. material: messing verchromt. wandabstand: 18mm. plattenstärke: max. 10mm, mehr mit längerer madenschraube. lochbohrung: Ø4mm.

EN style, modular information system, wallmounted. according to your needed length, screw the Ø6mm bars together. by combining the two lengths (300mm and 400mm) starting from 600mm all heights in 100mm-steps are possible. panels can be mounted lateral or frontal to the bar. height and width of your system can be enlarged anytime thanks to the modular design. material: brass chrome-plated. wall distance: 18mm. panel thickness: max. 10mm, more with longer allen screw. panel hole: Ø4mm.

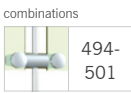

1	ASTA	cromo chrom chrome	1box	pz/st/pc
	YWS3006CM	300mm, 2pcs		
2	YWS4006CM	400mm, 2pcs		
2	CIMA	cromo chrom chrome		
	YWS1008CM	40pcs		
40				
3	FERMO	cromo chrom chrome		
	YWS1530CM	40pcs		
40				
4	MAESTRO	cromo chrom chrome		
	YWS1525CM	40pcs		
40				
5	LATO	cromo chrom chrome		
	YWS1545CM	40pcs		
40				
6	CUPIDO	cromo chrom chrome		
	YWS1568CM	10pcs		
10				



infoglass

MADE IN EU design by KD

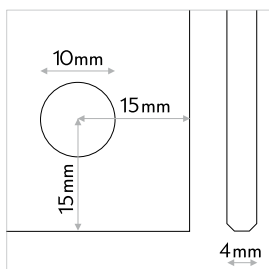
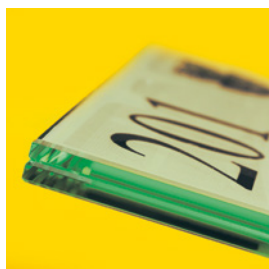

IT pannelli in vetro. elegante vetro temperato con bordi lucidati e sfaccettati con un'angolatura di 45°. da utilizzare singolarmente o in coppia per sistemi a sandwich. i pannelli sono già forati e completi con anellini di protezione. materiale: vetro temperato.

DE objektschild aus glas. temperiertes glas mit 45°-facettengeschliffenen kanten in ansprechender optik. einzeln oder im sandwich-system verwendbar. bereits mit lochbohrungen und inklusive glasschutzringe. material: temperiertes glas.

EN elegant glass sign. tempered glass with 45° faceted polished edge. use it single or double for sandwich systems. comes already with holes, glass protecting rings included. material: tempered glass.

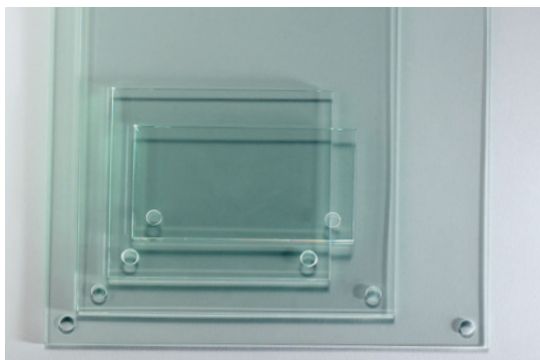

vetro glas glass	external size	nr. fori nr. bohrungen no. holes	pz/st/pc
IGA7L2M4	80x150mm, 1pc	nr 2	
IGA6L2M4	135x150mm, 1pc	nr 2	
IGA4L4M4	337x215mm, 1pc	nr 4	
IGA3L4M4	460x300mm, 1pc	nr 4	
IG100100L2M4	100x100mm, 1pc	nr 2	
IG100100L4M4*	100x100mm, 1pc	nr 4	
IG100200L2M4	100x200mm, 1pc	nr 2	
IG100200L4M4*	100x200mm, 1pc	nr 4	
IG150150L2M4	150x150mm, 1pc	nr 2	
IG150150L4M4	150x150mm, 1pc	nr 4	

* fino ad esaurimento scorte | solange vorrat reicht | while stock last

infoplate glassgreen

MADE IN EU design by KD

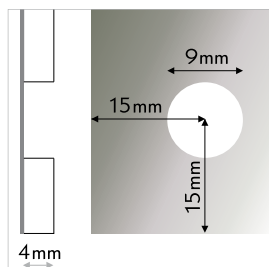
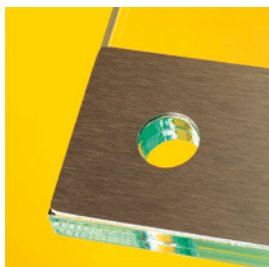

IT pannelli in acrilico color vetro. pannelli in acrilico che sembrano vetro ma che sono molto più leggeri. utilizzabile in molti modi per informazioni, indicatori di direzione o targhe. disponibili in molti formati e spessori con angoli politi e perfettamente rifiniti. altri formati disponibili a richiesta. particolarmente elegante e alla moda: la combinazione con le lastrine e i nostri distanziali in acciaio inox della linea STEEL. materiale: acrilico trasparente color vetro.

DE objektschild in glasgrünem acrylglas. leichter als glas und optisch kaum zu unterscheiden. vielseitig verwendbar, in vielen grössen und stärke, mit polierten schnittkanten. ihre wunschausführung bieten wir auf anfrage gerne an. besonders elegant und im trend: die kombination mit blende und befestigungen aus unserer edelstahllinie STEEL. material: acrylglas glasgrün transparent.

EN glassgreen acrylic signs. looks like glass but it is much lighter. multi-purpose usable for way-finding, information or pricing. comes in common sizes with polished edges. customized sizes on demand. elegant and trendy: the combination with faceplate and spacers of our stainless steel product line STEEL. material: glassgreen transparent acrylic glass.



vetro glas glass	external size	spessore stärke thickness	nr. fori nr. bohrungen no. holes	pz/st/pc
IGLA7L2M4*	80x150mm, 1pc	4mm	nr 2	
IGLA4L4M4*	337x215mm, 1pc	4mm	nr 4	

lastra d'acciaio spazzolato | edelstahlblende | faceplate brushed steel

IGL700500STEEL*	30x500mm, 1pc		nr 2	
-----------------	---------------	--	------	--

* fino ad esaurimento scorte | solange vorrat reicht | while stock last

infoplate square

MADE IN EU design by KD

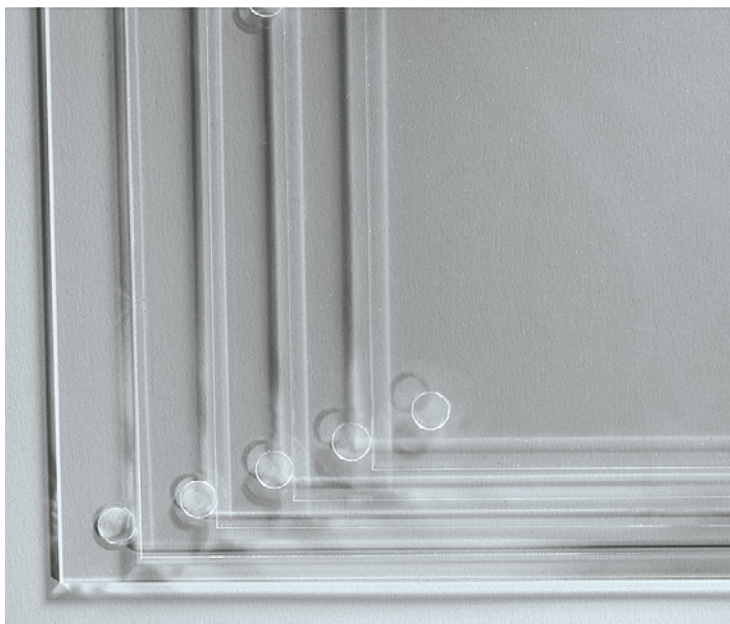
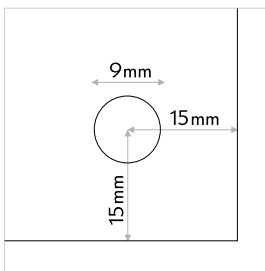

IT pannelli in acrilico trasparente. utilizzabili in molti modi per informazioni, indicatori di direzione, targhe. acrilico colato di alta qualità, disponibile in molti formati e spessori. una moderna tecnica laser garantisce una lavorazione esatta e angoli politi e perfettamente rifiniti. altri formati disponibili a richiesta. materiale: acrilico trasparente.

DE objektschild in transparentem acrylglas. vielseitig verwendbar für beschilderung, information oder preisauszeichnung. hochwertiges gegossenes acrylglas in einer grossen auswahl an grössen und stärke. moderne lasertechnik garantiert exakte bearbeitung und polierte schnittkanten. ihre wunschausführung bieten wir auf anfrage gerne an. material: acrylglas klar transparent.

EN transparent acrylic signs. multi-purpose usable for way-finding, information or pricing. high-quality casted acrylic glass comes in a wide range of size and thickness. state-of-the-art laser cutting ensures exact processing and polished edges. customized sizes on demand. material: clear transparent acrylic glass.

acrilico acryl acrylic	external size	spessore stärke thickness	nr. fori nr. bohrungen no.holes	pz/st/pc
IEA7L2M2	80x150mm, 1pc	2mm	nr 2	
IEA7L2M4	80x150mm, 1pc	4mm	nr 2	
IEA6L2M4	135x150mm, 1pc	4mm	nr 2	
IEA6L2M8*	135x150mm, 1pc	8mm	nr 2	
IE150150L2M4	150x150mm, 1pc	4mm	nr 2	
IE150150L2M8*	150x150mm, 1pc	8mm	nr 2	
IE150150L4M4	150x150mm, 1pc	4mm	nr 4	
IE150150M4*	150x150mm, 1pc	4mm	nr 0	
IE200200L2M8*	200x200mm, 1pc	8mm	nr 2	
IEA4L4M4	337x215mm, 1pc	4mm	nr 4	
IEA3L4M2*	460x300mm, 1pc	2mm	nr 4	
IEA3L4M4	460x300mm, 1pc	4mm	nr 4	
IE400400L4M2*	400x400mm, 1pc	2mm	nr 4	

* fino ad esaurimento scorte | solange vorrat reicht | while stock last



infoquick

MADE IN EU design by KD

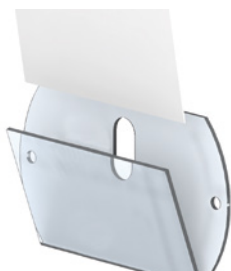
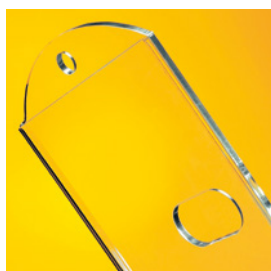

IT acrilico trasparente per un veloce cambio di informazioni. montare a parete infoquick ed inserire l'informazione. il plex piegato a tasca si apre facilmente. ideale dove si debbano cambiare informazioni frequentemente: menu e listini in ambito gastronomico, liste di eventi e manifestazioni in hotel, in centri per congressi e conferenze, in uffici o in ospedali, offerte del giorno in negozi o in agenzie di viaggio, corso delle azioni in banca, indicatori di direzione in uffici pubblici e assicurazioni. disponibile nei formati piú comuni e in diversi spessori. materiale: acrilico trasparente.

DE schnellinformation in transparentem acryl.infoquick wandmontieren und information einschleiben. die gebogene acryltasche lässt sich leicht öffnen und schliessen.ideal wo info häufig ausgetauscht wird: menükarten im gastronomiebetrieb, veranstaltungshinweise in hotels, konferenz- und seminarräumen, raumbelegung im büro oder krankenhaus, tagesangebote im einzelhandel oder reisebüro, aktienkurse in banken, hinweise in behörden und versicherungen. lieferbar in gängigen grössen und diversen stärke. material: acrylglas transparent.

EN quick information in transparent acrylic. wallmount infoquick and insert your information. the poster pocket opens and closes easily. perfect for often replacements: menu at restaurants, event notes at the hotel, for conferences and seminars, room signs at offices or in hospitals, daily offers at shops or travel agencies, stockquotation in banks, notes in boards and insurances. available in common sizes and different thicknesses. material: transparent acrylic glass.



acrilico acryl acrylic	external size	spessore stärke thickness	nr. fori nr. bohrungen no.holes	pz/st/pc
IQA7L2M2	57x190mm, 1pc	2mm	nr 2	
IQA6L2M3	105x190mm, 1pc	3mm	nr 2	
IQA5L2M3	149x250mm, 1pc	3mm	nr 2	
IQA4L4M4	297x288mm, 1pc	4mm	nr 4	
IQA3L4M5	420x409mm, 1pc	5mm	nr 4	

infoplate round

MADE IN EU design by KD

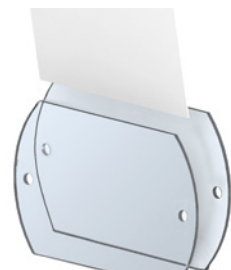
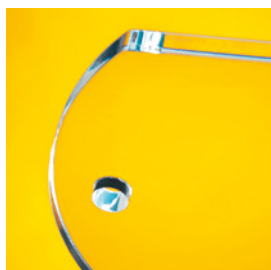

IT pannelli arrotondati in acrilico trasparente. elegante alternativa ai classici infoplate con una grande varietà di utilizzo: segnaletica, indicatori di direzione o anche come decorazione. angoli politi e perfettamente rifiniti, lavorazione esatta data da una moderna tecnica al laser. disponibile nei formati piú comuni e in diversi spessori. materiale: acrilico trasparente.

DE gerundetes, transparentes objektschild. formschöne alternative mit vielseitigen gestaltungsmöglichkeiten für leitsysteme, information oder dekoration. polierte schnittkanten, exakte bearbeitung durch moderne lasertechnik. lieferbar in gängigen grössen und diversen stärke. material: acrylglas transparent.

EN rounded, transparent sign. shapely alternative choice with manifold possibilities for signage, information or decoration. polished edges thanks to state-of-the-art lasercut. available in common sizes and different thicknesses. material: transparent acrylic glass.

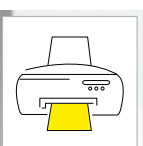

acrilico acryl acrylic	external size	spessore stärke thickness	nr. fori nr. bohrungen no.holes	pz/st/pc
IA7L2M4	57x190mm, 1pc	4mm	nr 2	
IA6L2M4	105x190mm, 1pc	4mm	nr 2	
IA4L4M4	297x288mm, 1pc	4mm	nr 4	
IA3L4M2*	420x409mm, 1pc	2mm	nr 4	
IA3L4M4	420x409mm, 1pc	4mm	nr 4	
I700500L4M4	900x550mm, 1pc	4mm	nr 4	

* fino ad esaurimento scorte | solange vorrat reicht | while stock last

fiSSO maxipack

MADE IN EU design by KD

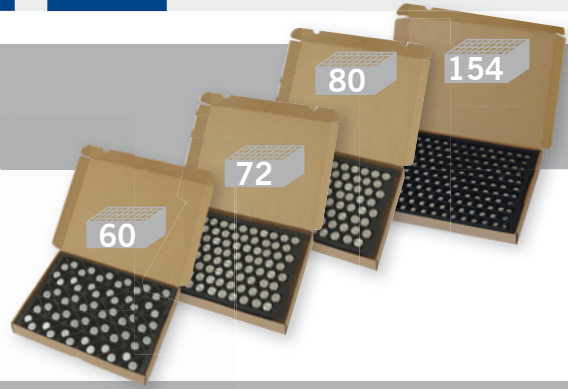

mix alu pag. | s. | p. 410-411



mix alu 1313 **mix alu 1320** **mix alu 1818** **mix alu 2330**

A 13x13mm B 13x20mm C 18x20mm D 23x30mm

order extra

1
 4

titanio titan titan	1box	pz/st/pc	oro gold gold	1box	pz/st/pc
B FMAMP1320TI			B FMAMP1320MGD		
C FMAMP1818TI			C FMAMP1818MGD		
D FMAMP2330TI			D FMAMP2330MGD		
nero schwarz black			argento silber silver		
B FMAMP1320MSZ			A FMXMP1313AL		
C FMAMP1818MSZ			B FMXMP1320AL		
D FMAMP2330MSZ			C FMAMP1818AR		
			D FMAMP2330AR		

three | four | six pag. | s. | p. 407



fisso three **fisso four** **fisso six**

A B C

154

order extra

1
 4

cromo chrom chrome	1box	pz/st/pc	oro gold gold	1box	pz/st/pc	argento silber silver	1box	pz/st/pc
A FFTMP1621CM			A FFTMP1621GD			A FFTMP1621AR		
B FFFMP1621CM			B FFFMP1621GD			B FFFMP1621AR		
C FFSMP1621CM			C FFSMP1621GD			C FFSMP1621AR		
rame satinato kupfer matt matt copper			steel look steel look steel look			bronzo veneziano bronze veneziano venetian brass		
A FFTMP1621MCO			A FFTMP1621IX			A FFTMP1621VB		
B FFFMP1621MCO			B FFFMP1621IX			B FFFMP1621VB		
C FFSMP1621MCO			C FFSMP1621IX			C FFSMP1621VB		

rapid pag. | s. | p. 406



order extra

ORINGIX15
1box pz/st/pc
 500

1 4

cromo chrom chrome	1box	pz/st/pc	oro gold gold	1box	pz/st/pc	steel look	1box	pz/st/pc
FRAMP1520CM			FRAMP1520GD			FRAMP1520IX		
argento silber silver			rame satinato kupfer matt matt copper			bronzo veneziano bronze veneziano venetian brass		
FRAMP1520AR			FRAMP1520MCO			FRAMP1520VB		

distanziatori a parete | wandmontiert | on the wall

fiSSO



midi

pag. | s. | p. 395



order extra

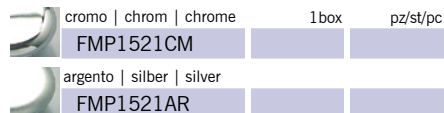
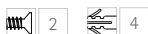
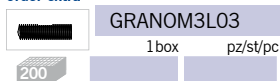

maxi

pag. | s. | p. 402



order extra

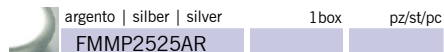
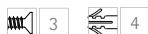
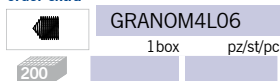

border

pag. | s. | p. 403



order extra

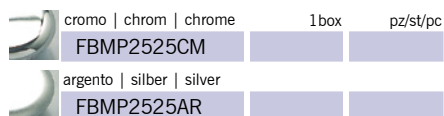
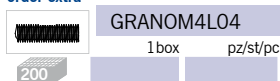

corner

pag. | s. | p. 403



order extra

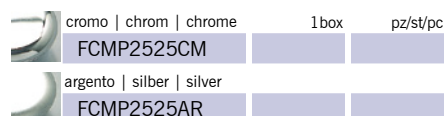
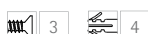
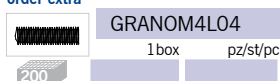

fixxo

pag. | s. | p. 433



order extra

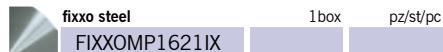
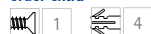

steel 13

pag. | s. | p. 434



order extra

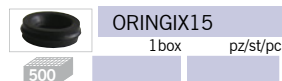

steel 13/13 13x15mm



order extra



acciaio | stahl | steel 1 box pz/st/pc

FSMP1315IX

steel 13/20 13x20mm

acciaio | stahl | steel

FSMP1320IX

steel 13/30 13x30mm



order extra



acciaio | stahl | steel 1 box pz/st/pc

FSMP1330IX

steel 15 & 20

pag. | s. | p. 434-435



order extra

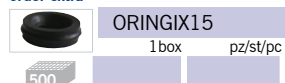

steel 15/15 15x15mm



order extra



acciaio | stahl | steel 1 box pz/st/pc

FSMP1515IX

steel 20/20 20x20mm



order extra



acciaio | stahl | steel 1 box pz/st/pc

FSMP2020IX

steel 25

pag. | s. | p. 435



order extra

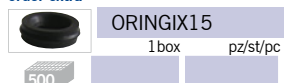

acciaio | stahl | steel 1 box pz/st/pc

FSMP2525IX

mix

pag. | s. | p. 412



mix 13&13 13x13mm



order extra



Cromo | chrom | chrome 1 box pz/st/pc

FMXMP1313M8CM

mix 19/25 19x25mm



order extra



Argento | Silber | silver 1 box pz/st/pc

FMXMP1925M12AR

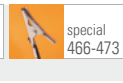
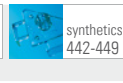
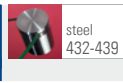

plumatic pag. | s. | p. 454

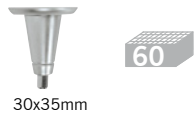

order extra
2 4

cromo chrom chrome	1box	pz/st/pc
FPMMP3530CM		
argento silber silver		
FPMMP3530AR		

perla pag. | s. | p. 459



order extra
154
GRANOM4L04
1box pz/st/pc
200

cromo chrom chrome	1box	pz/st/pc
FPEMP10CM		

klipser pag. | s. | p. 442



15 x ø15mm	1box	pz/st/pc
FKLMP1515		
20 x ø20mm		
FKLMP2020		
30 x ø20mm		
FKLMP2030		

ring kombo pag. | s. | p. 392



acciaio stahl steel	1box	pz/st/pc
FRINGMP15KB		

accessories



vite schraube screw	1box	pz/st/pc
1 SKKR3L35	200	
2 SKKR4L35	200	
3 SKKR4L45	200	
tassello dübel anchor	1box	pz/st/pc
4 TASS6L30NY	100	

IT anellini protetti-vetro, da utilizzare con INFOGLASS, confezionati in buste, con diametro interno Ø8mm o Ø4mm.

DE glasschutzringe, für die verwendung mit INFOGLASS. im nylonbeutel mit innendurchmesser Ø8mm oder Ø4mm.

EN glass protection ring, to be used with INFOGLASS products. in nylon bags with inner diameter Ø8mm or Ø4mm.

5	ARIP15/8	ø8mm	1box	pz/st/pc
6	ARIP15/4	ø4mm		

IT chiavi con impugnatura blu ACHI15 per brugole da 1,5mm e con impugnatura gialla ACHI20 per brugole da 2mm.

DE inbusschlüssel mit blauem griff ACHI15 für inbusschrauben 1,5mm, mit gelbem griff ACHI20 für inbusschrauben 2mm.

EN allen keys with blue handle ACHI15 for 1,5mm allen screws, with yellow handle ACHI20 for 2mm allen screws.

7	ACHI15	1,5mm		pz/st/pc
8	ACHI20	2mm		

IT biadesivo a peduncoli plastici removibili, forte tenuta.

DE selbstklebendes in sich schließendes pilzkopfband, vielfach wieder lösbar, stark haftend.

EN self-locking reclosable adhesive tape with mushroom heads, strong durable hold.

9	AVE2525	25x25mm 4 set	1box	pz/st/pc
	AVE252000	2m25mm	1 roll	1m

IT biadesivo in rotoli. larghezza: 15mm. rotolo: 9m.

DE doppelklebeband auf rolle. breite: 15mm. rolle: 9m.

EN double adhesive tape. width: 15mm. length: 9m.

	ATP1509	9m	1 roll	1m
--	---------	----	--------	----

IT cavo d'acciaio Ø1,7mm o d'acciaio inox Ø1,2mm, sempre rivestito di pvc. rotoli da 5m, 25m e 500m. per sistemi in tensione con gli articoli delle linee fisso e fly.

DE stahlseil Ø1,7mm oder edelstahlseil Ø1,2mm, jeweils pvc beschichtet. konfektionen zu 5m, 25m und 500m. für seilspannsysteme mit fisso- oder fly-produkten.

EN steel cable Ø1,7mm or stainless steel cable Ø1,2mm, both pvc coated. in coils of 5m, 25m and 500m. for suspension systems with fisso- or fly-products.

inox stahl steel			1m
AFIL05	Ø1,7mm, 5m		
AFIL25	Ø1,7mm, 25m		
ABOB500	Ø1,7mm, 500m		
inox edelstahl stainless steel			1m
AFILIX05	Ø1,2mm, 5m		
AFILIX25	Ø1,2mm, 25m		
AFILIX500	Ø1,2mm, 500m		

distanziali a parete | wandmontiert | on the wall

fisso